



iN·Command[®]

CONTROL SYSTEMS

JRVCS2

RV CONTROL AND MONITORING SYSTEM

Installation and Operation Manual

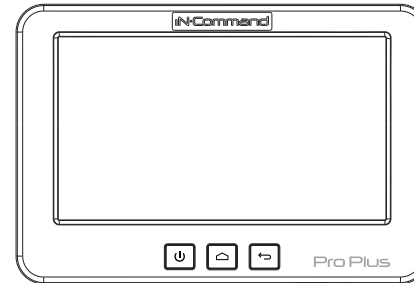
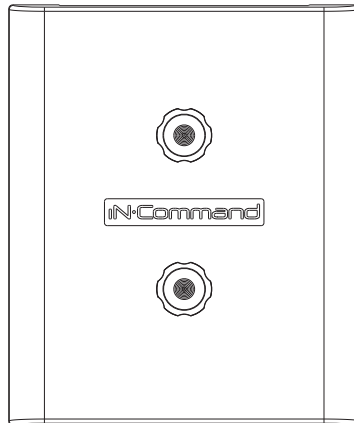

Patent # (D776,068)
Patent # (D762,644)
Patent # (9,679,635)

Important Safety Information



Read the iN-Command Manual, and these warnings and instructions carefully before using this product. Failure to follow the use instructions in this owner's manual, or improper use of the Mobile Application, Display Commander and/or Body Control Module, could result in personal injury, including death.

Do not operate while vehicle is being driven. The Mobile Application, Display Commander and/or Body Control Module should not be used while the vehicle is being driven. Use of the Mobile Application, Display Commander and/or Body Control Module while the vehicle is being driven is dangerous and may cause personal injury or property damage.

For adult use only. The Mobile Application, Display Commander and Body Control Module are intended for adult use only, and are not to be used by persons under the age of 18. Use by children may cause personal injury or property damage.

Operate only when you have a clear line of sight. Do not operate any moving parts (including, but not limited to, awnings, jacks and slides), unless you have a clear line of sight to the moving part. The Mobile Application, Display Commander or Body Control Module may be used only if you are giving instructions to, and receiving instructions from, another person at least age 18 or older who can clearly see the moving part. Failure to follow these instructions may result in serious personal injury or property damage.

Do not operate under the influence of alcohol or drugs. Do not operate the Mobile Application, Display Commander or Body Control Module while under the influence of alcohol or drugs. Doing so may result in personal injury or property damage.

Avoid moisture. To reduce the risk of fire or electric shock, do not expose this equipment to rain or moisture.

Use recommended accessories. To reduce the risk of fire or electric shock and annoying interference, use only the recommended accessories.

• TABLE OF CONTENTS

TABLE OF CONTENTS	3	Clear Passcode	17
INTRODUCTION	4	MOBILE DEVICES:	18
Thank You!	4	Pairing Mobile Device to DC	19
Features	4	CHECKING ACTIVE BLUETOOTH SESSION	24
Precautions	4	SOFTWARE UPDATE*	25
Packing List.....	4	RESET: FLOOR PLAN	28
INSTALLATION	5	SYSTEM CALIBRATION*	29
Tools and Supplies.....	5	AUTO GENERATOR START	31
Disconnecting the battery.....	5	TROUBLESHOOTING	32
Selecting the Mounting Location	5		
Mounting the Display Commander (DC)	5		
WIRING	6		
SETUP MENU LIST	7		
SAFETY LOCKOUT	8		
OVERRIDE SWITCHES*	9		
SPECIFICATIONS	10		
FCC Notes	10		
PASSCODE PROTECTION	11		
MENU	11		
Text Editing.....	11		
Scroll List Editing*	12		
Tanks.....	13		
Lights	13		
Slides	14		
Awnings	14		
Jacks.....	14		
Triggers	14		
Alarm Inputs.....	15		
Passcode	15		
Set Passcode Timer	17		
Change Passcode	17		

• INTRODUCTION

• Thank You!

Thank you for choosing a iN-Command product. We hope you will find the instructions in this owner's manual clear and easy to follow. If you take a few minutes to look through it, you'll learn how to use all the features of your new iN-Command system for maximum enjoyment.

• Features

Features of iN-Command system include:

- Simultaneous control by up to three Android Devices and one iOS Device
- Control four zones of Interior Lighting
- Control three zones of Exterior Lighting
- Monitor all water and fuel tank levels
- Control and monitor the Water Heater (switches between LP, AC, or both)
- Control and monitor the Water Pump
- Control and monitor the Generator (including all faults)
- Control Awnings & Awning Lights
- Control Electric and Hydraulic Slides
- Control Jacks (non-automatic function)
- 4 Programmable Auxiliary 12V Triggers
- 4 Alarm Inputs (12V)
- Monitor Battery Voltage with Low Voltage Alert
- Auto Generator Start

• Precautions

• Use the Proper Power Supply.

This product is designed to operate with a 12 volt DC, negative ground battery system (the standard system in a North American vehicle).

• Use Authorized Service Centers.

Do not attempt to disassemble or adjust this precision product; contact a professional for assistance.

• Avoid Moisture.

To reduce the risk of fire or electric shock, do not expose this equipment to rain or moisture.

• Avoid Cleaning Products.

The front of this unit should only be cleaned with a slightly damp cloth. Do not use cleaning products.

• Use Recommended Accessories.

TO REDUCE THE RISK OF FIRE OR ELECTRIC SHOCK AND ANNOYING INTERFERENCE, USE ONLY THE RECOMMENDED ACCESSORIES.

• Packing List

(1) Cover, (2) Thumb Screws

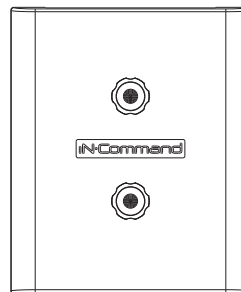

(1) Display Commander (DC)



(1) Body Control Module (BCM)

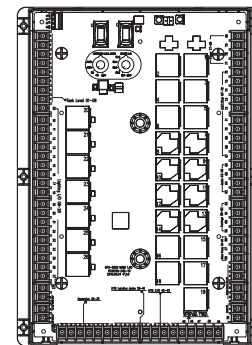

• INSTALLATION

It's a good idea to read all of the instructions before beginning the installation.

• Tools and Supplies

You will need these tools and supplies to install your iN-Command:

- Phillips screwdriver
- #2 square drive bit
- Wire cutters and strippers
- Electrical tape
- Volt meter/test light
- Crimping tool
- Fork Crimp connectors
- Minimum of 24 gauge wire required to connect DC to BCM
- 10 gauge wire for power and slide connections
- 14 and 18 gauge wire for all other connections
- Four #8 PH (0.164" x 0.75") screws for the DC
- Six #8 PH (0.164" x 1.0") screws for the BCM

• Disconnecting the battery

To prevent a short circuit, be sure to turn off 12V power and remove the negative (-) battery cable prior to installation.

• Selecting the Mounting Location

Select a mounting location, taking care to avoid the following:

- Places exposed to heat-radiating appliances such as electric heaters
- Adjacent to other equipment that radiates heat
- Poorly-ventilated or dusty places
- Moist or humid locations

• Mounting the Display Commander (DC)

- Use the mounting hole diagram to measure and cut a mounting hole, allowing space below for future programming via USB drive
- Route power wires through the hole and connect
- Check and ensure correct operation
- Mount the unit using four #8 PH (0.164" x 0.75") screws
- Attach Trim ring

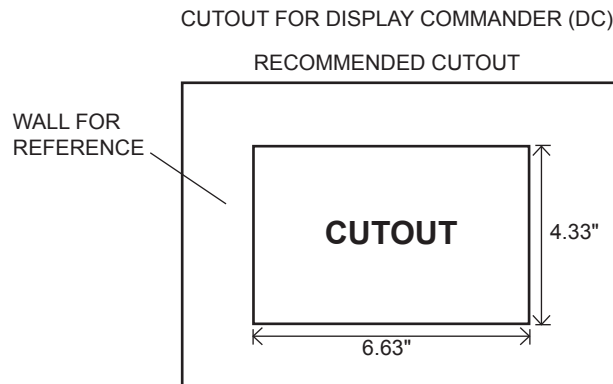

NOTE: Before cutting the mounting hole, make sure the area behind the mounting location is clear of wires, fuel and vacuum or water lines; ensure there is at least a 2.75" clearance below the Display Commander to allow for programming by USB stick.

• **WIRING**

The wiring diagram depicts all the wiring connections required for proper operation of the unit.

BODY CONTROL MODULE (BCM) CONNECTIONS

PIN NO.	WIRE GAUGE	DESCRIPTION
1	18 AWG	FRESH TANK 1 (IN)
2	18 AWG	FRESH TANK 2 (IN)
3	18 AWG	BLACK TANK 1 (IN)
4	18 AWG	BLACK TANK 2 (IN)
5	18 AWG	GRAY TANK 1 (IN)
6	18 AWG	GRAY TANK 2 (IN)
7	18 AWG	GRAY TANK 3 (IN)
8	18 AWG	TANK COMMON 7V (OUT)
9	14 AWG	LIGHT GROUP 1 + (IN)
10	14 AWG	LIGHT GROUP 1 - (IN/OUT)
11	14 AWG	LIGHT GROUP 1 + (OUT)
12	14 AWG	LIGHT GROUP 2 + (IN)
13	14 AWG	LIGHT GROUP 2 - (IN/OUT)
14	14 AWG	LIGHT GROUP 2 + (OUT)
15	14 AWG	LIGHT GROUP 3 + (IN)
16	14 AWG	LIGHT GROUP 3 - (IN/OUT)
17	14 AWG	LIGHT GROUP 3 + (OUT)
18	14 AWG	LIGHT GROUP 4 + (IN)
19	14 AWG	LIGHT GROUP 4 - (IN/OUT)
20	14 AWG	LIGHT GROUP 4 + (OUT)
21	14 AWG	EXTERIOR LIGHTS + (IN)
22	14 AWG	EXTERIOR LIGHTS - (IN/OUT)
23	14 AWG	EXTERIOR LIGHTS + (OUT)
24	14 AWG	SECURITY LIGHTS + (IN)
25	14 AWG	SECURITY LIGHTS - (IN/OUT)
26	14 AWG	SECURITY LIGHTS + (OUT)
27	14 AWG	AWNING LIGHTS + (OUT)
28	14 AWG	AWNING LIGHTS - (OUT)
29	14 AWG	AUX FUEL TANK + (IN)
30	14 AWG	AUX FUEL TANK - (OUT)
31		AUX TRIGGER 1 (OUT)
32	18 AWG	GEN START GND (OUT)

PIN NO.	WIRE GAUGE	DESCRIPTION
33	18 AWG	GEN PRIME/STOP GND (OUT)
34	18 AWG	GEN SERVICE +12V (IN)
35	18 AWG	GEN HOUR METER +12V (IN)
36	14 AWG	GEN FUEL TANK LEVEL (IN)
37	14/18 AWG	GEN GROUND
38	16 AWG	LANDING GEAR +12V (OUT)
39	16 AWG	LANDING GEAR GROUND (OUT)
40	16 AWG	HYDRAULIC VALVE EXTEND
41	16 AWG	HYDRAULIC VALVE RETRACT
42	16 AWG	HYDRAULIC VALVE +12V
43	16 AWG	HYDRAULIC VALVE GROUND
44		AUX TRIGGER 2 (OUT)
45		AUX TRIGGER 3 (OUT)
46		AUX TRIGGER 4 (OUT)
47		ALARM INPUT +12V
48		ALARM INPUT +12V
49		ALARM INPUT +12V
50		ALARM INPUT +12V
51	16 AWG	LOCKOUT SIGNAL +12V (IN)
52	18 AWG	WATER HEATER GROUND
53	18 AWG	WATER HEATER ON (GAS)
54	18 AWG	WATER HEATER ON (ELECTRIC)
55	18 AWG	WATER HEATER FAULT
56	14 AWG	WATER PUMP +12V (OUT)
57	14 AWG	WATER PUMP -12V (IN/OUT)
58	14 AWG	WATER PUMP +12V (OUT)
59	14 AWG	AWNING 2 -12V (OUT)
60	14 AWG	AWNING 2 +12V (OUT)
61	14 AWG	AWNING 1 -12V (OUT)
62	14 AWG	AWNING 1 +12V (OUT)
63	10 AWG	REAR JACKS -12V (OUT)
64	10 AWG	REAR JACKS +12V (OUT)

PIN NO.	WIRE GAUGE	DESCRIPTION
65	10 AWG	FRONT JACKS -12V (OUT)
66	10 AWG	FRONT JACKS +12V (OUT)
67	10 AWG	ELECTRIC SLIDE 5 -12V (OUT)
68	10 AWG	ELECTRIC SLIDE 5 +12V (OUT)
69	10 AWG	ELECTRIC SLIDE 4 -12V (OUT)
70	10 AWG	ELECTRIC SLIDE 4 +12V (OUT)
71	10 AWG	ELECTRIC SLIDE 3 -12V (OUT)
72	10 AWG	ELECTRIC SLIDE 3 +12V (OUT)
73	10 AWG	ELECTRIC SLIDE 2 -12V (OUT)
74	10 AWG	ELECTRIC SLIDE 2 +12V (OUT)
75	10 AWG	ELECTRIC SLIDE 1 -12V (OUT)
76	10 AWG	ELECTRIC SLIDE 1 +12V (OUT)
77	10 AWG	CHASSIS GROUND (IN)
78	10 AWG	AWNING +12V (IN)
79	10 AWG	ELECTRIC SLIDE +12V (IN)
80	10 AWG	BCM +12V (IN)
81	24 AWG	+12 VDC (Connect to DC)
82	24 AWG	TX (Connect to DC RX)
83	24 AWG	RX (Connect to DC TX)
84	24 AWG	GND (Connect to DC)

• **SETUP MENU LIST**

ITEM	SELECTION
Generator	No, Propane, Gasoline
Fuel Station	No, Yes
Fresh Water Tank 2	No, Yes
Black Water Tank 2	No, Yes
Gray Water Tank 2	No, Yes
Grey Water Tank 3	No, Yes
Awning 1	No, Yes
Awning 2	No, Yes
Hydraulic Slide Room	No, Yes
Electric Slide 1	No, Yes
Electric Slide 2	No, Yes
Electric Slide 3	No, Yes
Electric Slide 4	No, Yes
Electric Slide 5	No, Yes
Light Group 1	No, Yes
Light Group 2	No, Yes
Light Group 3	No, Yes
Light Group 4	No, Yes
Awning Light	No, Yes
Trigger 1	No, Momentary, Latch

Trigger 2	No, Momentary, Latch
Trigger 3	No, Momentary, Latch
Trigger 4	No, Momentary, Latch
Alarm 1	+12V Input
Alarm 2	+12V Input
Alarm 3	+12V Input
Alarm 4	+12V Input
Hitch	No, Electric,Hydraulic
Rear Landing Jacks	No, Yes

• SAFETY LOCKOUT

iN-Command is equipped with a Safety Lockout feature to ensure certain system functions are unavailable during transit.

When the Brake Signal on the tow vehicle is activated, the iN-Command will lock down all motorized functions. The Display Commander and mobile devices will also display “Travel Lock On” in red letters and the affected buttons will cease to activate.

The lights, water pump, water heater, generator, and tanks sensors will continue to function.

To turn the Travel Lock off, the “Unlock” button on the Display Commander, inside the RV, must be pressed.

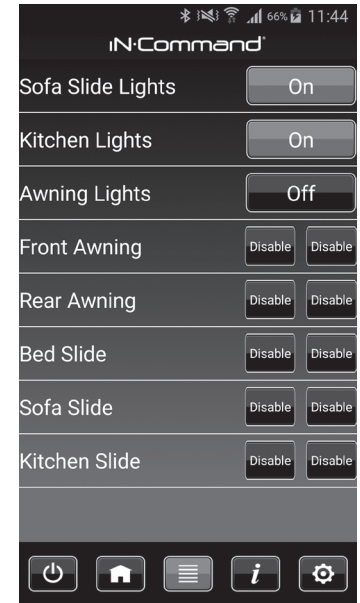
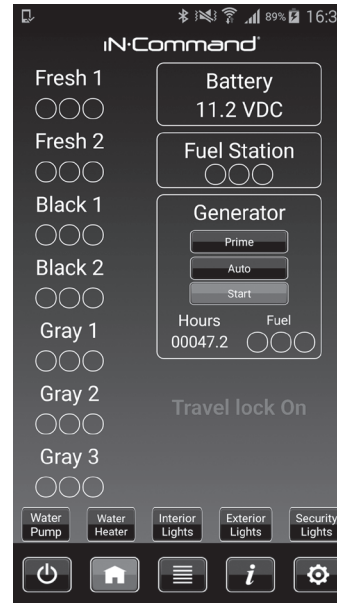
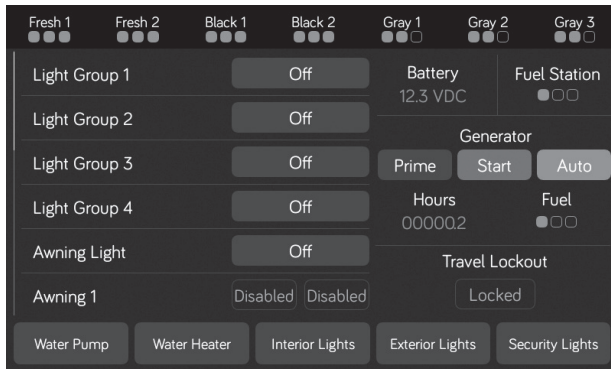

• OVERRIDE SWITCHES*

The Body Control Module has a bank of override switches.

The rotary switches below each rocker switch correspond to an electric function* made by the Display Commander.

The left switch controls the awning and jacks.

The right switch controls the slides.

To use the override switches, locate the switch needed to actuate the desired component. Rotate the switch underneath the rocker switch to select the motor. Press up or down on the switch.

The switch is momentary and will activate the motor only while pressed in either direction.

*** The hydraulic overrides are located on the hydraulic pump; consult the hydraulic pump owner's manual for more information.**

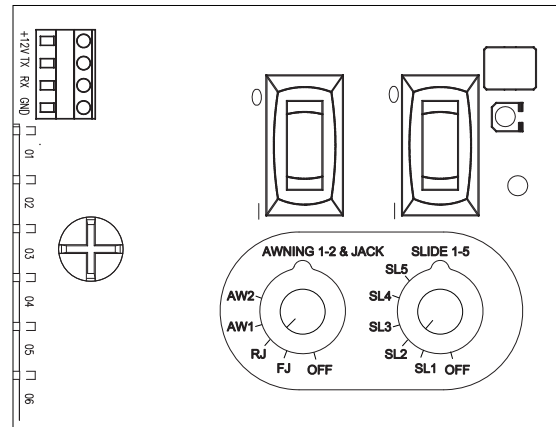

• SPECIFICATIONS

Display Commander (DC)

Operating Voltage	12VDC
Maximum Current Draw	1.5A@9VDC
Minimum Operating Voltage	9VDC
Maximum Operating Voltage	16VDC

Body Control Module (BCM)

Operating Voltage	12VDC
Maximum Current Draw	8.5A@12VDC
Minimum Operating Voltage	9VDC
Maximum Operating Voltage	16VDC

JRVCS2 System

EPROM Non-Volatile Memory	YES
Bluetooth Version	4.0 BLE

General

Body Control Module	14.9" (W) x 17.9" (D) x 1.8" (H)
Display Commander	7.7" (W) x 5.2"(D) x 1.3" (H)

• FCC Notes

WARNING! Changes or modifications to this unit not expressly approved by the party responsible for compliance could void the user's authority to operate the equipment.

NOTE: This equipment has been tested and found to comply with the limits for a Class B digital device, pursuant to Part 15 of the FCC Rules. These limits are designed to provide reasonable protection against harmful interference in a residential installation.

This equipment generates, uses and can radiate radio frequency energy and, if not installed and used in accordance with the instructions, may cause harmful interference to radio communications.

However, there is no guarantee that interference will not occur in a particular installation. If this equipment does cause harmful interference to radio or television reception, which can be determined by turning the equipment off and on, the user is encouraged to try to correct the interference by one or more of the following measures:

- Reorient or relocate the receiving antenna.
- Increase the separation between the equipment and receiver.
- Connect the equipment into an outlet on a circuit different from that to which the receiver is connected.
- Consult the dealer or an experienced radio/TV technician for help.

• PASSCODE PROTECTION

A passcode is required to access the system.

On the first time use of the system, the user is required to enter and confirm a new passcode.

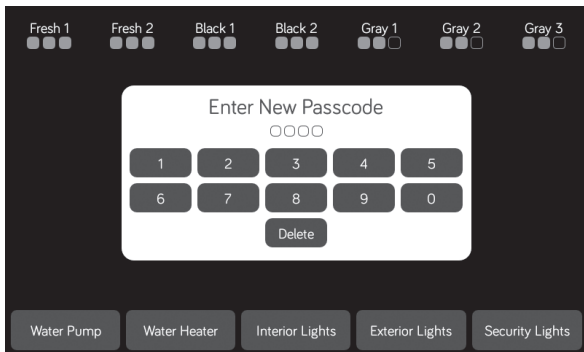

Confirm the new passcode.

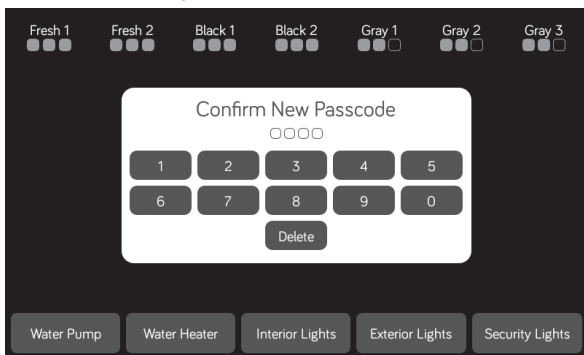

• MENU

From the Menu screen you can:

- Edit iN-Command function text
- Reposition functions
- Enable/disable functions
- Change the switch properties (from momentary to latch)
- See the status of iN-Command
- Connect devices with Bluetooth
- Change the passcode
- Reset the floor plan
- Control the brightness of the DC screen
- View iN-Command's Legal documents and customer support information.

The Setup button is used by the manufacturer.

• Text Editing

1. Select "Menu"

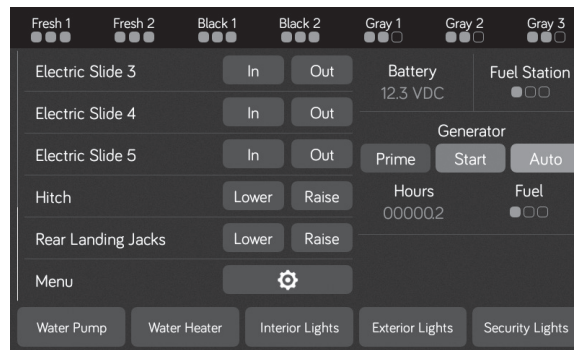

2. Press “Edit” to enter “Edit” page

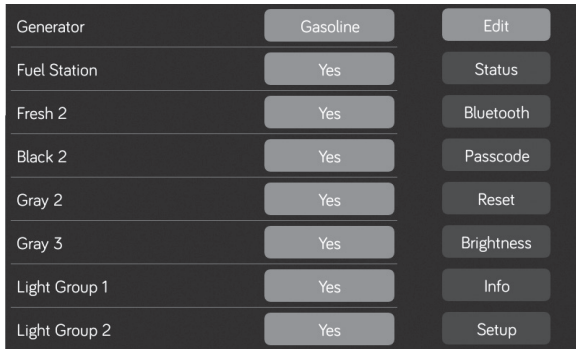

3. Long press the intended text, e.g., “Awning1”.



4. A device rename window will open. Press “OK” after completing the text editing.

Note: Editing the text on the DC will not change the text on a device's app.

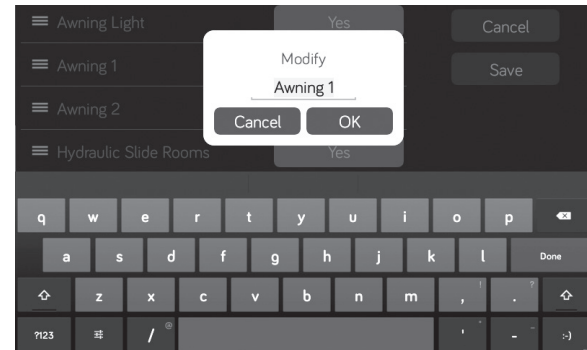

• Scroll List Editing*

1. Select “Menu”.



2. Press “Edit” to enter “Edit” page

Generator	Gasoline	Edit
Fuel Station	Yes	Status
Fresh 2	Yes	Bluetooth
Black 2	Yes	Passcode
Gray 2	Yes	Reset
Gray 3	Yes	Brightness
Light Group 1	Yes	Info
Light Group 2	Yes	Setup

3. Press and hold the “≡” icon before the device name and drag to move the device to a new location, “Electric Slide 1” is shown as an example.

≡ Awning Light	Yes	Cancel
≡ Awning 1	Yes	Save
≡ Awning 2	Yes	
≡ Hydraulic Slide Rooms	Yes	
≡ Electric Slide 1		
≡ Electric Slide 2	Yes	
≡ Electric Slide 3	Yes	
≡ Electric Slide 4	Yes	

* The iN-command system supports multiple functions. Functions can be added, but will require modification and or addition of external components, wiring, and plumbing.

• Tanks

Fresh water tanks, Black water tanks, and Gray water tanks can be added to the system.

Generator	Gasoline	Edit
Fuel Station	Yes	Status
Fresh 2	Yes	Bluetooth
Black 2	Yes	Passcode
Gray 2	Yes	Reset
Gray 3	Yes	Brightness
Light Group 1	Yes	Info
Light Group 2	Yes	Setup

• Lights

Light Groups can be added to the system.

Light Group 1	Yes	Edit
Light Group 2	Yes	Status
Light Group 3	Yes	Bluetooth
Light Group 4	Yes	Passcode
Awning Light	Yes	Reset
Awning 1	Yes	Brightness
Awning 2	Yes	Info
Hydraulic Slide Rooms	Yes	Setup

• **Slides**

Slides can be added to the system.

Hydraulic Slide Rooms	Yes	Edit
Electric Slide 1	Yes	Status
Electric Slide 2	Yes	Bluetooth
Electric Slide 3	Yes	Passcode
Electric Slide 4	Yes	Reset
Electric Slide 5	Yes	Brightness
Hitch	Electric	Info
Rear Landing Jacks	Yes	Setup

• **Awnings**

Awnings can be added to the system.

Awning 1	Yes	Edit
Awning 2	Yes	Status
Hydraulic Slide Rooms	Yes	Bluetooth
Electric Slide 1	Yes	Passcode
Electric Slide 2	Yes	Reset
Electric Slide 3	Yes	Brightness
Electric Slide 4	Yes	Info
Electric Slide 5	Yes	Setup

• **Jacks**

Jacks can be added to the system.

Hitch	Electric	Edit
Rear Landing Jacks	Yes	Status
Trigger 1	No	Bluetooth
Trigger 2	No	Passcode
Trigger 3	No	Reset
Trigger 4	No	Brightness
Alarm 1	No	Info
Alarm 2	No	Setup

• **Triggers**

Triggers can be added to the system. “Momentary” or “Latch” can be selected for each Trigger. Note: Desired devices need to be correctly wired to the BCM to function.

Trigger 1	Latch	Edit
Trigger 2	Latch	Status
Trigger 3	Momentary	Bluetooth
Trigger 4	Momentary	Passcode
Alarm 1	No	Reset
Alarm 2	No	Brightness
Alarm 3	No	Info
Alarm 4	No	Setup

• Alarm Inputs

Alarm Inputs can be added to the system.

Note: Desired devices need to be correctly wired to the BCM to function.

Trigger 1	Latch	Edit
Trigger 2	Latch	Status
Trigger 3	Momentary	Bluetooth
Trigger 4	Momentary	Passcode
Alarm 1	Yes	Reset
Alarm 2	Yes	Brightness
Alarm 3	Yes	Info
Alarm 4	Yes	Setup

• Passcode

1. Select "Menu".

Fresh 1	Fresh 2	Black 1	Black 2	Gray 1	Gray 2	Gray 3
Electric Slide 3	In	Out	Battery	Fuel Station		
Electric Slide 4	In	Out	12.3 VDC	●○○		
Electric Slide 5	In	Out	Generator			
Hitch	Lower	Raise	Prime	Start	Auto	
Rear Landing Jacks	Lower	Raise	Hours	Fuel		
Menu	⚙️					
Water Pump	Water Heater	Interior Lights	Exterior Lights	Security Lights		

2. Press "Passcode" to enter passcode setup.

Generator	Gasoline	Edit
Fuel Station	Yes	Status
Fresh 2	Yes	Bluetooth
Black 2	Yes	Passcode
Gray 2	Yes	Reset
Gray 3	Yes	Brightness
Light Group 1	Yes	Info
Light Group 2	Yes	Setup

2.1 Enter the correct passcode to proceed.

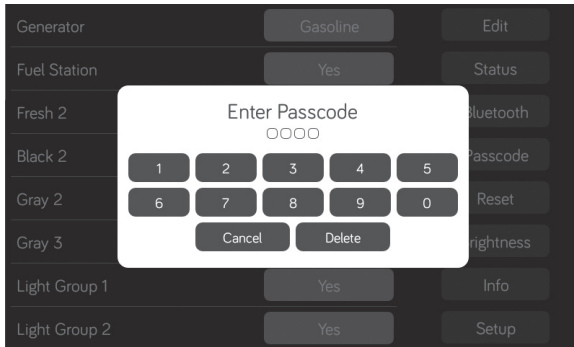

3.1 Passcode protection may be disabled or enabled by selecting Enable or Disable on the Change Passcode popup screen.

Enabled mode

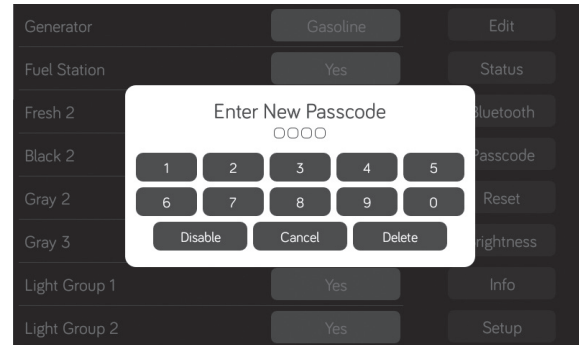

3. The passcode setup window will open.

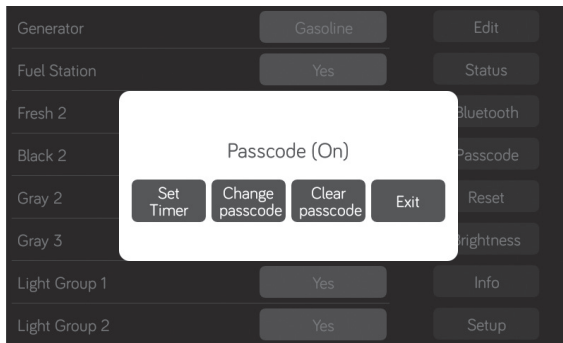

Disabled mode

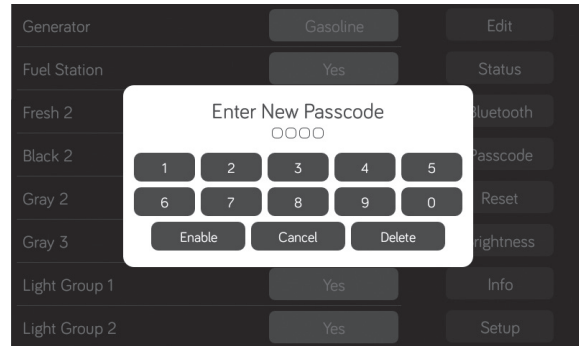

• Set Passcode Timer

Press the “Set Timer” button to select the idle time to activate the passcode protection.

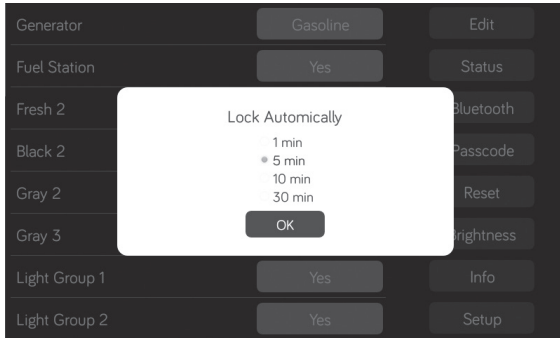

3. Confirm new passcode.

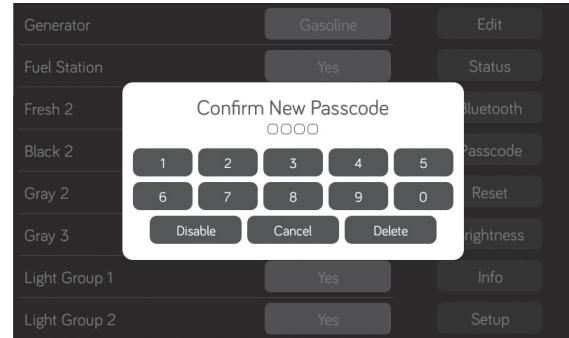

• Change Passcode

1. Press the “Change Passcode” button to change to a new passcode.
2. Enter the new passcode.

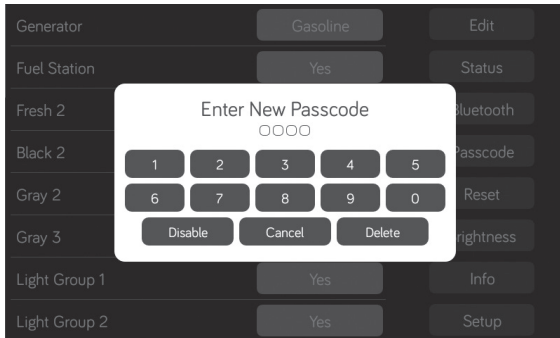

• Clear Passcode

Press the “Clear Passcode” button to clear the passcode. This will restart the APP, take the user to the End-User License Agreement, and have the user setup a new passcode.

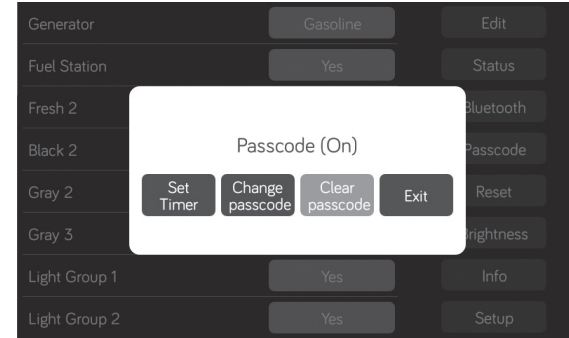

• MOBILE DEVICES:

iN-Command is able to pair to Android and iOS devices using the iN-Command App.

Visit the Google Play and Apple App stores on your mobile device to check compatibility of your device.

Seven mobile devices are able to be paired to iN-Command at one time, but only 1 iOS and 3 Android devices are able to be **actively** paired; meaning, 3 Android devices and 1 iOS device can all actively control the iN-Command functions.

To use another device not actively paired to iN-Command, 1 device needs to shut down its iN-Command App to allow another device to actively pair. To do this simply select the power button on the App or shut down the App in the device's settings menu.

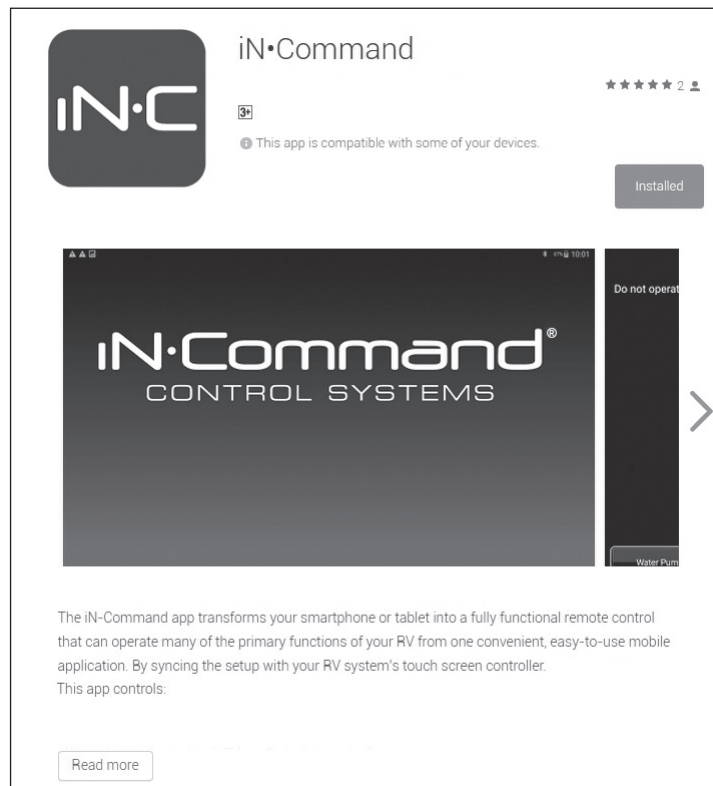

• Pairing Mobile Device to DC

1. On the DC:

1.1 Select "Menu".

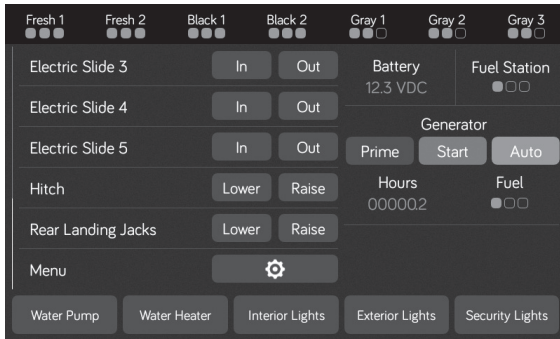

1.2 Select "Bluetooth".

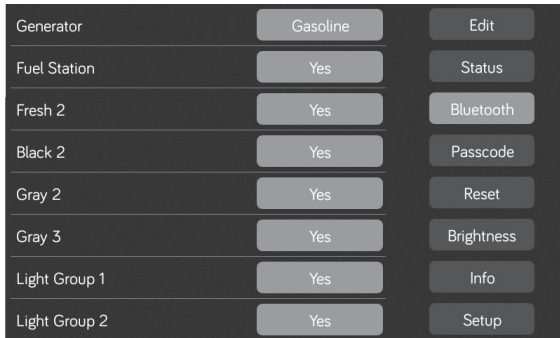

1.3 Currently, it shows no BT paired device connected to this DC.

Press the "Discover" button to activate the BT pairing mode.

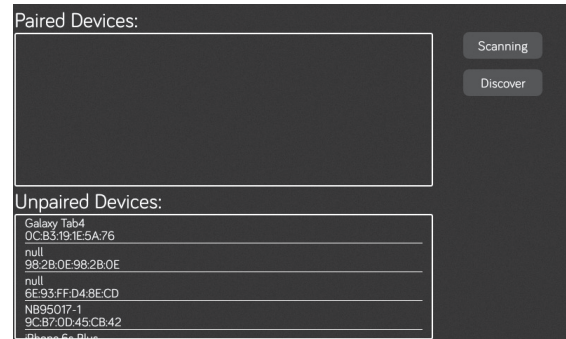

1.4 Press "Allow".

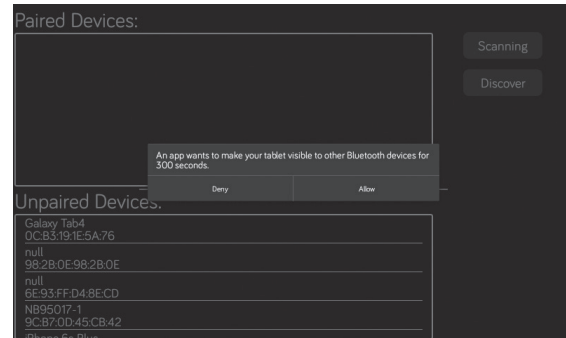

2. Android Mobile Device Pairing Steps:

2.1 Press “Bluetooth” on the “Setup” page to find the DC device.

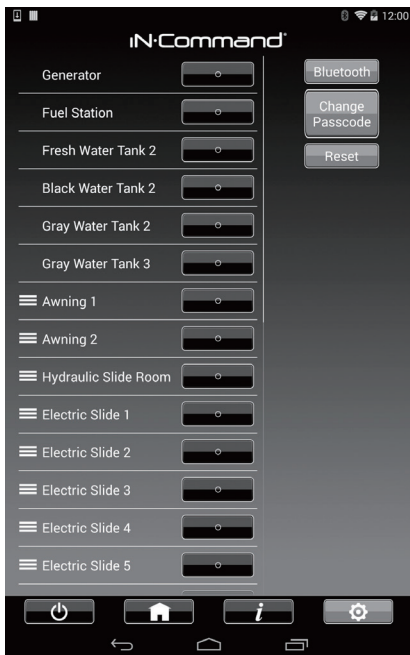

2.2 The Mobile APP will scan for the DC device.

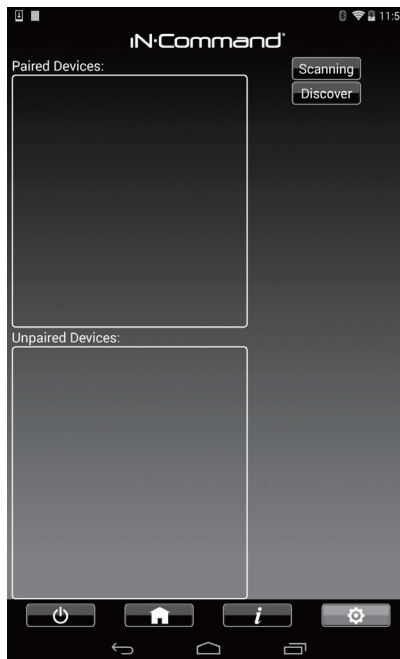

2.3 The DC will be displayed in the Unpaired Devices list in the format “JENSENDCXXXXXX”. Press the DC device in the list to pair with it.

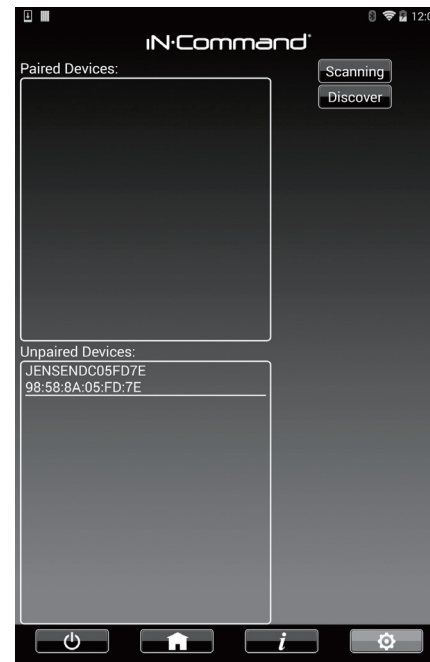

2.4 On the DC, a request message will appear. Press “Pair” to start the BT pairing and concurrently enter the same passkey on the Mobile device.

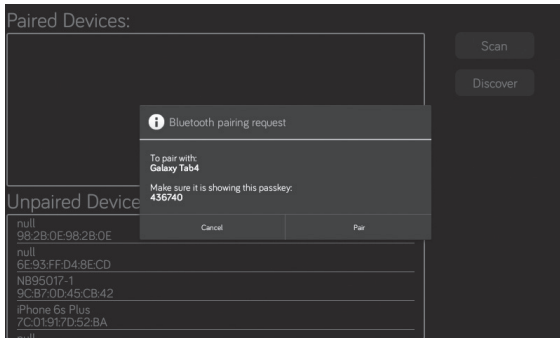

2.5 The DC now shows the Mobile device is paired.



3. Apple Mobile Device Pairing Steps:

3.1 Enable “Bluetooth” in the system settings of Apple mobile device.

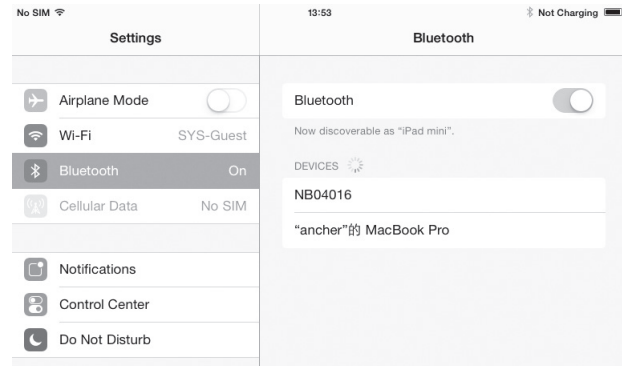

3.2 Press Scan on the DC Bluetooth page. Locate the Apple device in the Unpaired Device list. Select the Apple device by pressing it.

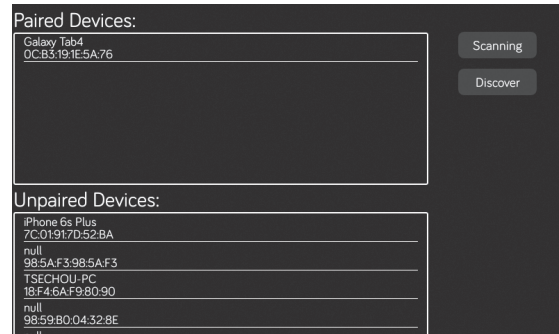

3.3 Press "Pair" in DC.

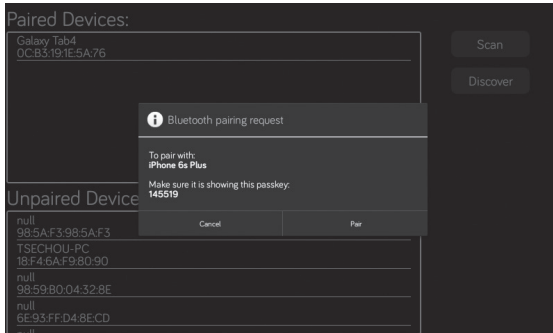

3.4 Press "Pair" in Apple mobile device.

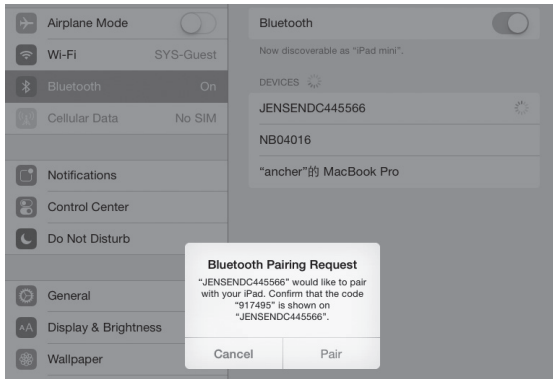

3.5 The DC will be displayed in the MY DEVICES list in the format "JENSENDCXXXXXX". Press the DC device to connect with it.

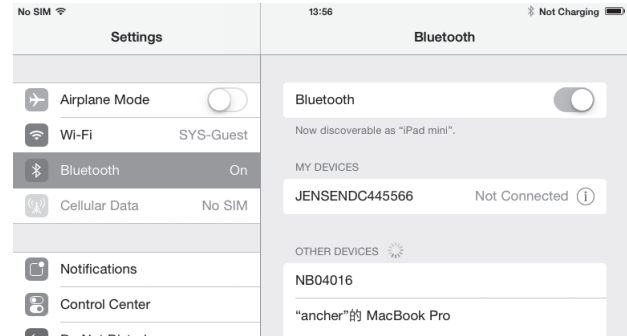

3.6 The Apple mobile device now shows the DC is connected.

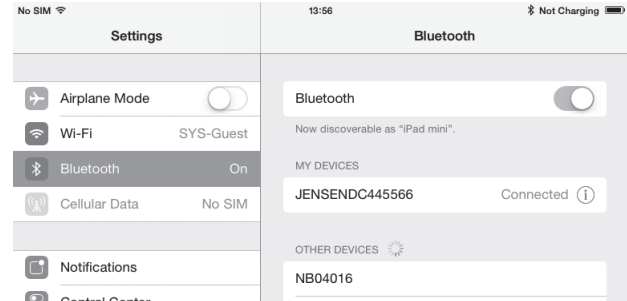

4. Reset Floor Plan

Press the "Reset" button in the Menu page to load the floor plan configuration from the DC. The current settings will be lost/replaced.

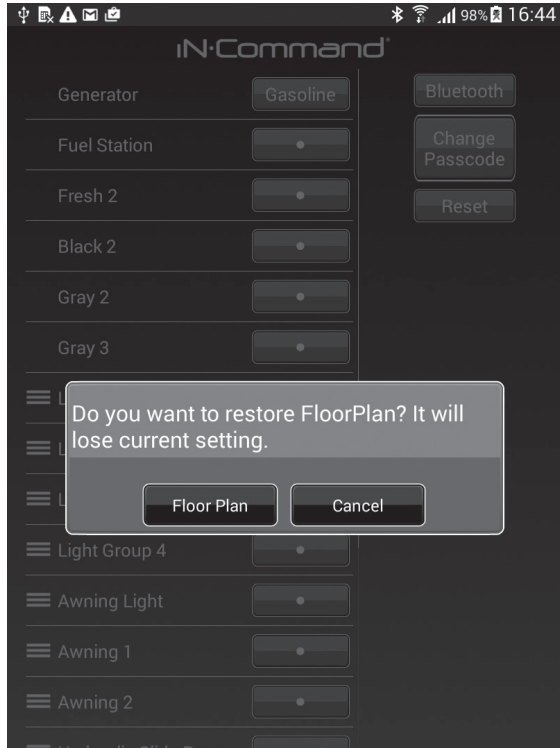

• CHECKING ACTIVE BLUETOOTH SESSION

1. Select "Status".

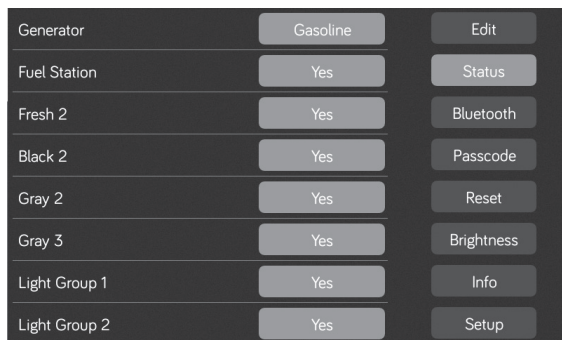

* To disconnect a handheld device, press "Disconnect", or simply shut down the device's app. This function is used to disconnect a device that is not actively being used, and to allow another device to be connected.

2. The page shows information of current active Bluetooth devices.

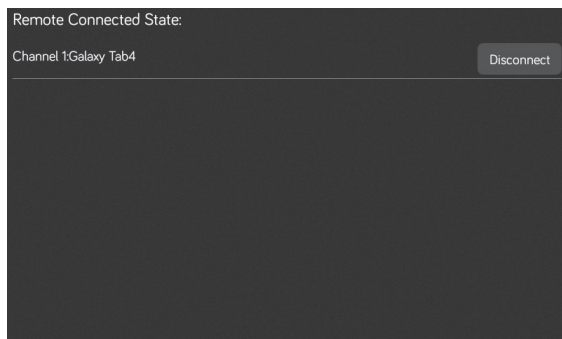

• SOFTWARE UPDATE*

Software updates include floorplan redesigns and app version updates.

1. Select “Menu” and insert USB drive into the DC USB port.



2. Select “Setup”

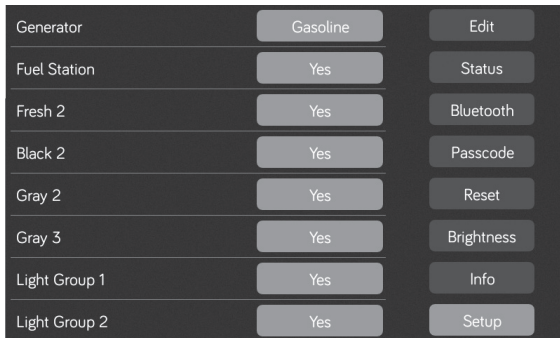

3. Enter engineer passcode to proceed.**

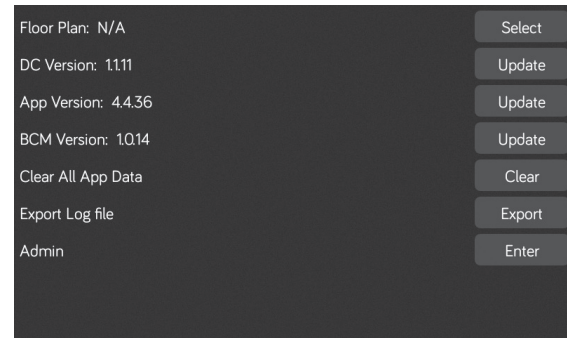
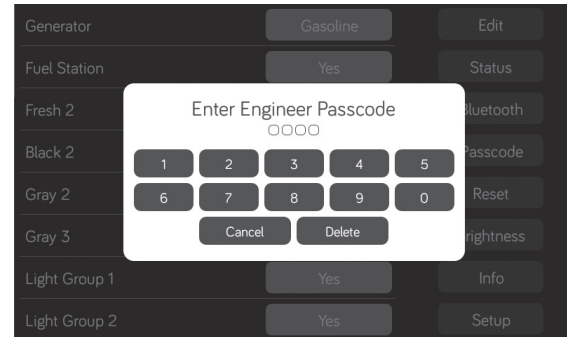

4. The system will look for specific file names for software updates.

- File name: "JRVCS2-AP Vxxxx.apk" → DC APP update, (xxxx is version number)
- File name: "JRVCS2-CM Vxxxx.bin" → BCM update, (xxxx is version number)
- File name: "JRVCS2-DC Vxxx.zip" → DC Android OS update
- File name: "xxxxxx.xml" → Floor Plan update

5. The system must be updated in the following order to prevent loss of communication between the DC and BCM.

1. Update DC
2. Update BCM
3. Update APP

5.1.1 Press OK to continue.

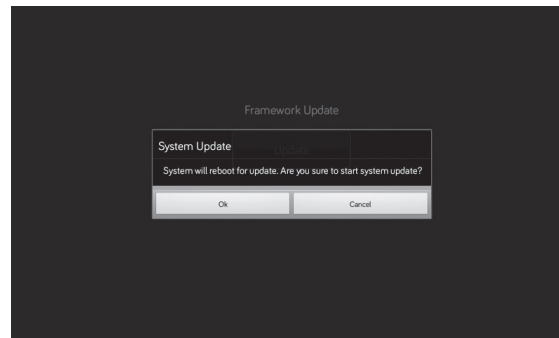

5.1 Press the DC Version "Update" button to update DC OS system.

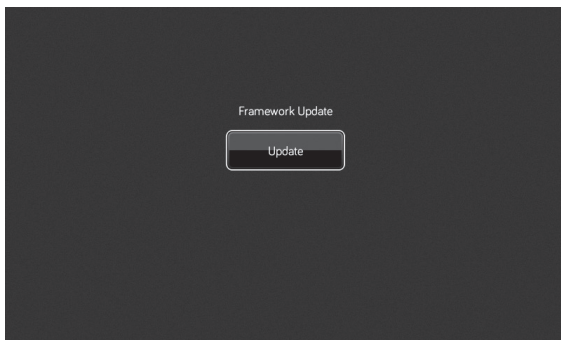

5.2 Press the BCM Version "Update" button to update the BCM firmware.

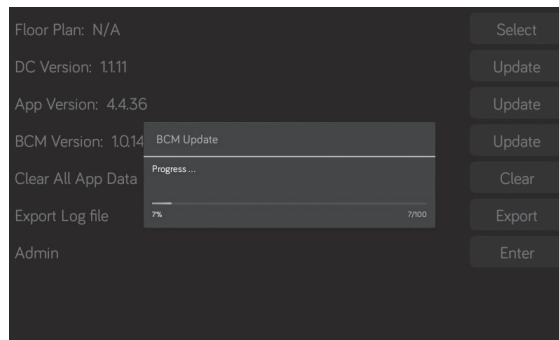

5.3 Press the APP Version “Update” button to update DC APP.

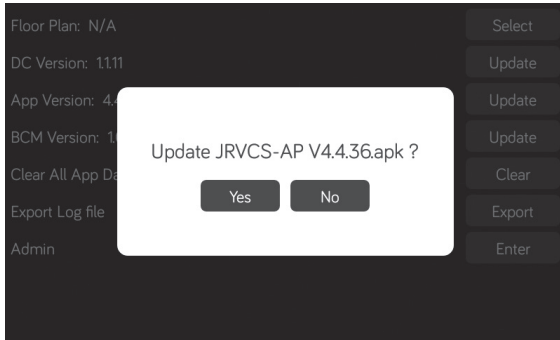

5.4 Press the Floor Plan “Select” button to select and load the new floor plan.

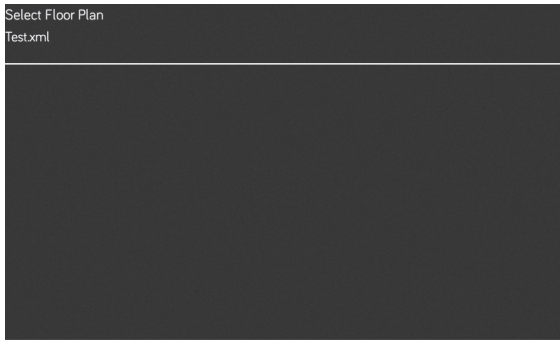

5.4.1 Press “OK” to confirm selection

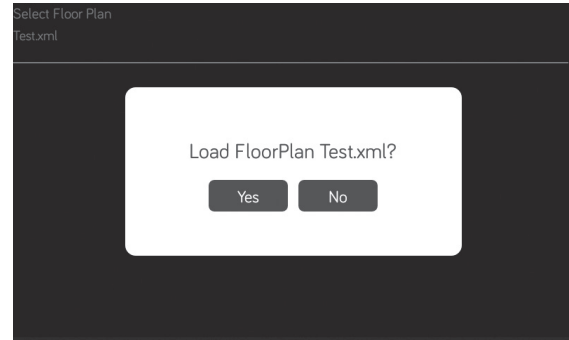

* If a software update is needed, go to <http://www.asaelectronics.com/in-command>

** The Engineering Passcode is used by the manufacturer for programming and troubleshooting purposes. Should there be a software issue, call ASA Electronics Technical Support at 1-877-845-8750 or email them at info@asaelectronics.com.

• RESET: FLOOR PLAN

To reset the floor plan to remove customization, select “Menu”.

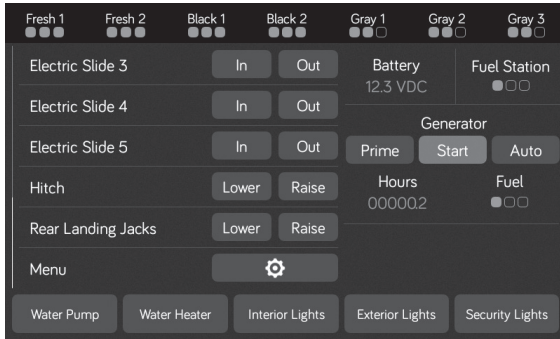

1. Select “Reset” to restore the system to previous setting.

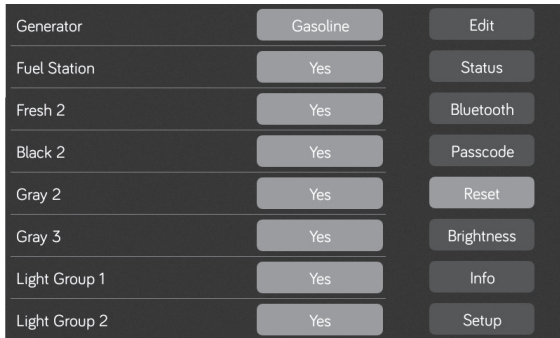

2. Select one of the two options to restore to a previous state. Current settings will be lost.

- Floor Plan: restores to previous floor plan settings from RV manufacturer.
- Factory: restores to default settings from ASA electronics.

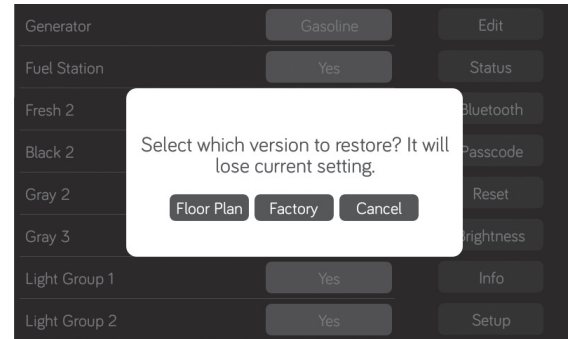

3. Wait for floor plan to complete update.

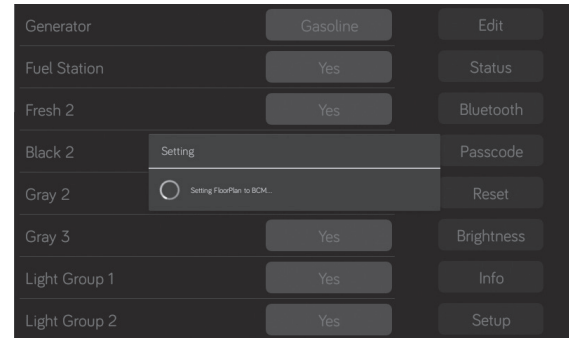

• **SYSTEM CALIBRATION***

1. Select "Menu".

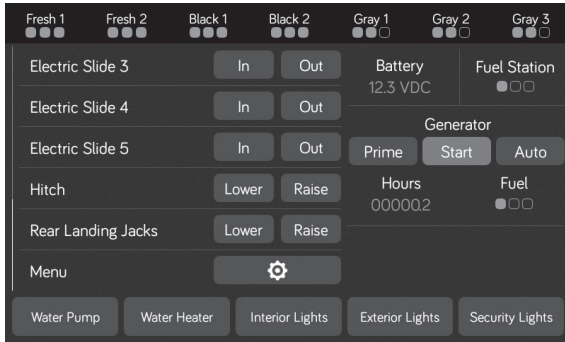

2. Select "Setup".

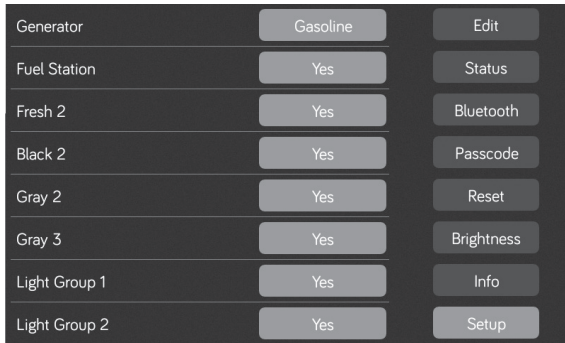

3. Enter engineer passcode to proceed.**

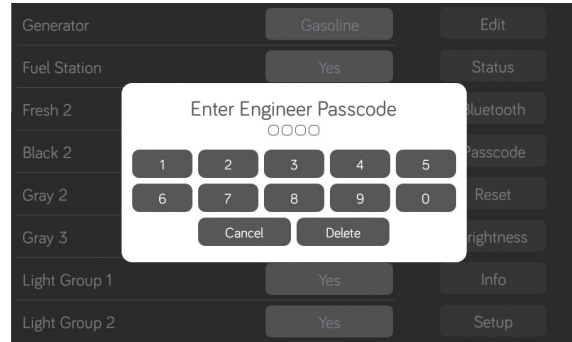

4. Select "Enter" corresponding to Admin.

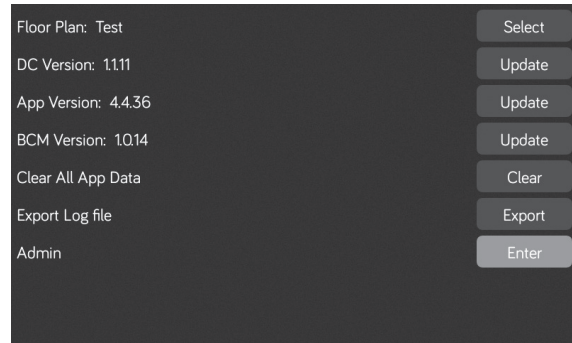

5. Enter admin passcode to proceed.**

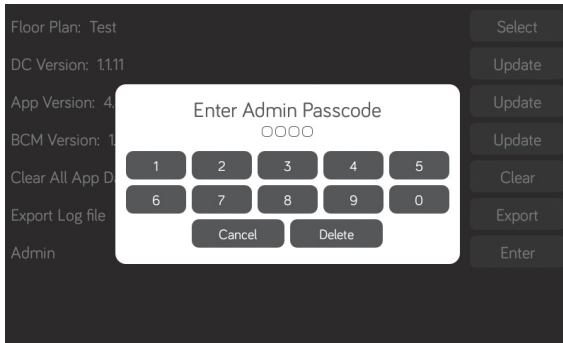

6. Select “Tanks” to set resistor reference value for every tank.

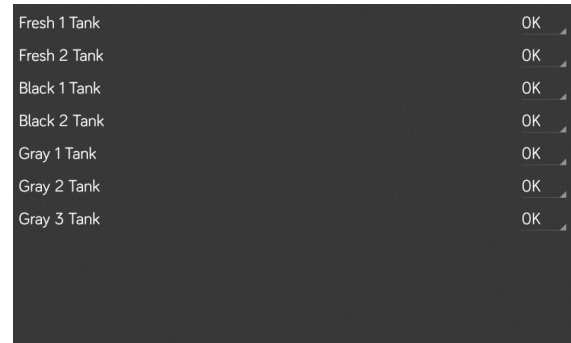

5.1 Make Selection.

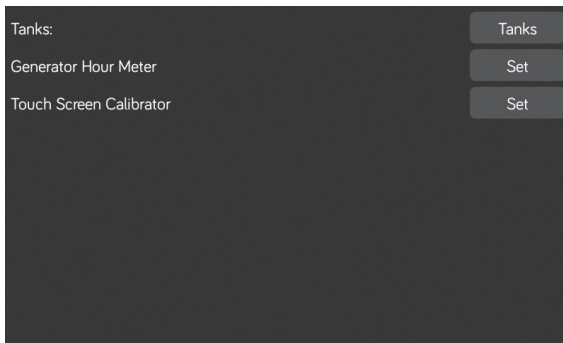

* The system should be calibrated by the manufacturer and only need to be accessed for troubleshooting.

** The Engineering and Admin Passcode is used by the manufacturer for programming and troubleshooting purposes.

Should there be a calibration issue, call ASA Electronics Technical Support at 1-877-845-8750 or email them at info@asaelectronics.com.

• AUTO GENERATOR START

1. Press the "Auto" button to activate AUTO GEN START.

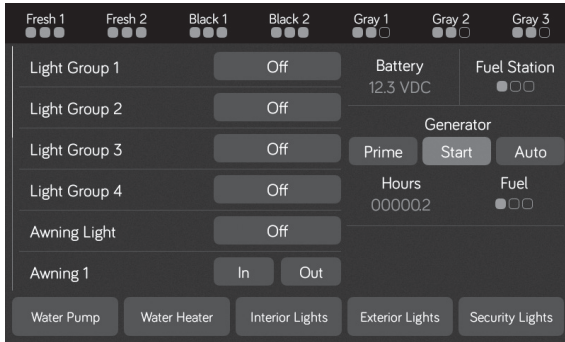

2. If the battery voltage is less than 11.8 volts for 3 minutes the system will start the generator.
To ensure the best performance and reliability, only one air conditioner and minimal 12V devices should be left on while using the Auto Generator feature.

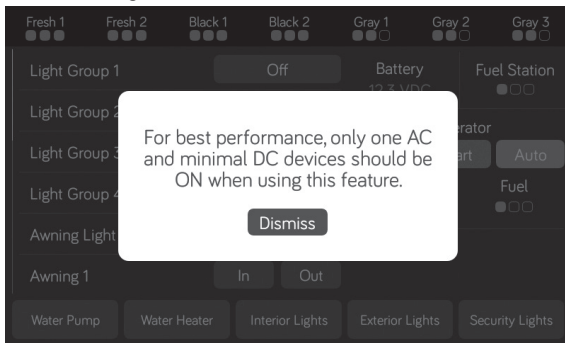

3. If the generator is started, the system will run the generator for 60 minutes.

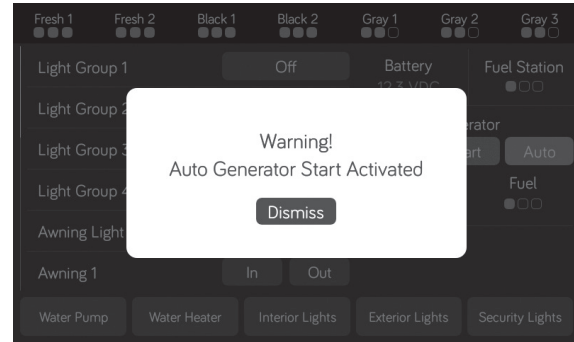

4. The system will attempt to start the generator 3 times. If it fails to start after the third attempt, the system will turn off the Auto feature and display Check Generator fault.

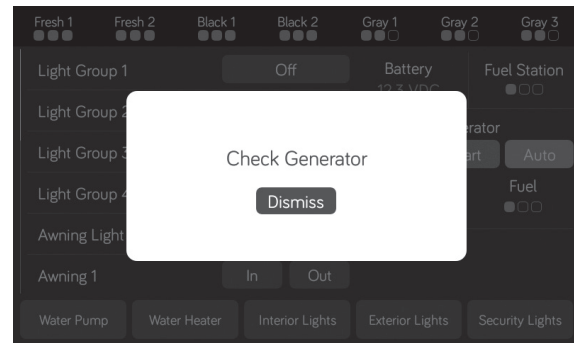

• TROUBLESHOOTING

Symptom	Solution
Display Commander (DC) will not turn ON or no front panel operation	Try cycling power with the ON/OFF button.
	Check main fuse in Distribution Panel.
	Check 12V+ on wire to DC (RED wire).
	Check Ground wire to DC.
No power to the Body Control Module (BCM)	Try cycling power with the ON/OFF button.
	Check the Red power LED is off.
	Check the fuse in the Distribution Panel.
	Check 12V+ on wire at pin 80.
	Check Ground wire at pin 77.
DC screen flashing on and off after installation	Disconnect 12V+ and Ground wires from the back of DC.
	Shut off all power to the BCM and DC.
	Reconnect 12V+ and Ground wires from the back of DC.
	Return power to BCM and DC.
Awnings do not move	Check 12V+ at Pin 78. Ensure the relay activates*.
Slide Rooms do not move	Check 12V+ at Pin 79. Ensure the relay activates*.
*Relay not activating	Replace the relay with one from an unused circuit by gently pulling it off the board. See label on BCM cover for relay identification.
DC shows 0V	Check to ensure RX & TX wires are connected properly



2602 Marina Drive • Elkhart, IN 46514

www.asaelectronics.com

www.jensenrvdirect.com

©2016 ASA Electronics LLC.