



Microwave Oven
INSTRUCTION MANUAL
MODEL: EC942K6BE



Read these instructions carefully before using your microwave oven, and keep it carefully.

If you follow the instructions, your oven will provide you with many years of good service.

SAVE THESE INSTRUCTIONS CAREFULLY

PRECAUTIONS TO AVOID POSSIBLE EXPOSURE TO EXCESSIVE MICROWAVE ENERGY

- (a) Do not attempt to operate this oven with the door open since open door operation can result in harmful exposure to microwave energy.
It is important not to defeat or tamper with the safety interlocks.
- (b) Do not place any object between the oven front face and the door or allows soil or cleaner residue to accumulate on sealing surfaces.
- (c) Do not operate the oven if it is damaged. It is particularly important that the oven door close properly and that there is no damage to the:
 - (1) DOOR (bent)
 - (2) HINGES AND LATCHES (broken or loosened)
 - (3) DOOR SEALS AND SEALING SURFACES
- (d) The oven should not be adjusted or repaired by anyone except properly qualified service personnel.

Specifications

Model:	EC942K6BE
Rated Voltage:	120V~60Hz
Rated Input Power(Microwave):	1550 W
Rated Output Power(Microwave):	900 W
Oven Capacity:	42L
Turntable Diameter:	Ø345mm
External Dimensions:	759X382X417 mm
Net Weight:	Approx. 30.8Kg

IMPORTANT SAFETY INSTRUCTIONS

When using electrical appliances basic safety precautions should be followed, including the following:

WARNING - To reduce the risk of burns, electric shock, fire, injury to persons or exposure to excessive microwave energy:

1. Read all instructions before using the appliance.
2. Read and follow the specific: "PRECAUTIONS TO AVOID POSSIBLE EXPOSURE TO EXCESSIVE MICROWAVE ENERGY" found on page 2.
3. This appliance must be grounded. Connect only to properly grounded outlet. See "GROUNDING INSTRUCTIONS" found on page 4.
4. Install or locate this appliance only in accordance with the provided installation instructions.
5. Some products such as whole eggs and sealed containers - for example, closed glass jars - are able to explode and should not be heated in this oven.
6. Use this appliance only for its intended use as described in the manual. Do not use corrosive chemicals or vapors in this appliance. This type of oven is specifically designed to heat, cook or dry food. It is not designed for industrial or laboratory use.
7. As with any appliance, close supervision is necessary when used by children.
8. Do not operate this appliance if it has a damaged cord or plug, if it is not working properly, or if it has been damaged or dropped.
9. This appliance should be serviced only by qualified service personnel. Contact nearest authorized service facility for examination, repair, or adjustment.
10. Do not cover or block any openings on the appliance.
11. Do not store this appliance outdoors. Do not use this product near water - for example, near a kitchen sink, in a wet basement, near a swimming pool, or similar location.
12. Do not immerse cord or plug in water.
13. Keep cord away from heated surface.
14. Do not let cord hang over edge of table or counter.
15. When cleaning surfaces of door and oven that comes together on closing the door, use only mild, nonabrasive soaps, or detergent applied with a sponge or soft cloth.
16. To reduce the risk of fire in the oven cavity:
 - 1). Do not overcook food. Carefully attend appliance when paper, plastic, or other combustible materials are placed inside the oven to facilitate cooking.
 - 2). Remove wire twist-ties from paper or plastic bag before placing bag in oven.
 - 3). If material inside of the oven ignite, keep oven door closed, turn oven off, and disconnect the power cord, or shut off power at the fuse or circuit breaker panel.
 - 4). Do not use the cavity for storage purposes. Do not leave paper products, cooking utensils, or food in the cavity when not in use.
17. Liquids, such as water, coffee, or tea are able to be overheated beyond the boiling point without appearing to be boiling. Visible bubbling or boiling when the container is removed from the microwave oven is not always present.

THIS COULD RESULT IN VERY HOT LIQUID SUDDENLY BOILING OVER WHEN THE CONTAINER IS DISTURBED OR A UTENSIL IS INSERTED INTO THE LIQUID.

To reduce the risk of injury to persons:

- 1) Do not overheat the liquid.
 - 2) Stir the liquid both before and halfway through heating it.
 - 3) Do not use straight-sided containers with narrow necks.
 - 4) After heating, allow the container to stand in the microwave oven for a short time before removing the container.
 - 5) Use extreme care when inserting a spoon or other utensil into the container.
18. Do not operate any heating or cooking appliance beneath the appliance.
(Exception: A microwave oven investigated for use above another heating appliance.)
 19. Do not mount unit over or near any portion of heating or cooking appliance.
(Exception: A microwave oven investigated for use above another heating appliance.)
 20. Do not mount over sink.
 21. Do not store anything directly on top of the appliance surface when the appliance is in operation.
 22. Clean Ventilation Hoods Frequently - Grease should not be allowed to accumulate on hood or filter.
 23. When flaming foods under the hood, turn the fan on.
 24. Use care when cleaning the vent-hood filter. Corrosive cleaning agents, such as lye-based oven cleaners, may damage the filter.
 25. Suitable for use above both gas and electric cooking equipment.

SAVE THESE INSTRUCTIONS

GROUNDING INSTRUCTIONS

This appliance must be grounded. In the event of an electrical short circuit, grounding reduces the risk of electric shock by providing an escape wire for the electric current. This appliance is equipped with a cord having a grounding wire with a grounding plug. The plug must be plugged into an outlet that is properly installed and grounded.

WARNING - Improper use of the grounding can result in a risk of electric shock.

Consult a qualified electrician or serviceman if the grounding instructions are not completely understood, or if doubt exists as to whether the appliance is properly grounded. If it is necessary to use an extension cord, use only a 3-wire extension cord that has a 3-blade grounded plug, and 3-slot receptacle that will accept the plug on the appliance. The marked rating of the extension cord shall be equal to or greater than the electrical rating of the appliance.

DANGER - Electric Shock Hazard

Touching some of the internal components can cause serious personal injury or death. Do not disassemble this appliance.

WARNING - Electric Shock Hazard

Improper use of the grounding can result in electric shock. Do not plug into an outlet until appliance is properly installed and grounded.

1. A short power-supply cord is provided to reduce the risks resulting from becoming entangled in or tripping over a longer cord.
2. Longer cord sets or extension cords are available and may be used if care is exercised in their use.
3. If a long cord or extension cord is used:
 - 1) The marked electrical rating of the cord set or extension cord should be at least as great as the electrical rating of the appliance.
 - 2) The extension cord must be a grounding-type 3-wire cord.
 - 3) The longer cord should be arranged so that it will not drape over the counter top or tabletop where it can be pulled on by children or tripped over unintentionally.

RADIO INTERFERENCE

1. Operation of the microwave oven may cause interference to your radio, TV or similar equipment.
2. When there is interference, it may be reduced or eliminated by taking the following measures:
 - 1) Clean door and sealing surface of the oven
 - 2) Reorient the receiving antenna of radio or television.
 - 3) Relocate the microwave oven with respect to the receiver.
 - 4) Move the microwave oven away from the receiver.
 - 5) Plug the microwave oven into a different outlet so that microwave oven and receiver are on different branch circuits.

UTENSILS

CAUTION - Personal Injury Hazard

Tightly-closed utensils could explode. Closed containers should be opened and plastic pouches should be pierced before cooking.

See the instructions on "Materials you can use in microwave oven or to be avoided in microwave oven."

There may be certain non-metallic utensils that are not safe to use for microwaving. If in doubt, you can test the utensil in question following the procedure below.

Utensil Test:

1. Fill a microwave-safe container with 1 cup of cold water (250ml) along with the utensil in question.
2. Cook on maximum power for 1 minute.
3. Carefully feel the utensil. If the empty utensil is warm, do not use it for microwave cooking.
4. Do not exceed 1 minute cooking time.

Materials you can use in microwave oven

Utensils	Remarks
Browning dish	Follow manufacturer* instructions. The bottom of browning dish must be at least 3/16 inch (5mm) above the turntable. Incorrect usage may cause the turntable to break.
Dinnerware	Microwave-safe only. Follow manufacturer's instructions. Do not use cracked or chipped dishes.
Glass jars	Always remove lid. Use only to heat food until just warm. Most glass jars are not heat resistant and may break.
Glassware	Heat-resistant oven glassware only. Make sure there is no metallic trim. Do not use cracked or chipped dishes.
Oven cooking bags	Follow manufacturer* instructions. Do not close with metal tie. Make slits to allow steam to escape.
Paper plates and cups	Use for short-term cooking/warming only. Do not leave oven unattended while cooking.
Paper towels	Use to cover food for reheating and absorbing fat. Use with supervision for a short-term cooking only.
Parchment paper	Use as a cover to prevent splattering or a wrap for steaming.

Materials you can use in microwave oven

Utensils	Remarks
Plastic	Microwave-safe only. Follow the manufacturer* instructions. Should be labeled "Microwave Safe". Some plastic containers soften, as the food inside gets hot. "Boiling bags" and tightly closed plastic bags should be slit, pierced or vented as directed by package.
Plastic wrap	Microwave-safe only. Use to cover food during cooking to retain moisture. Do not allow plastic wrap to touch food.
Thermometers	Microwave-safe only (meat and candy thermometers).
Wax paper	Use as a cover to prevent splattering and retain moisture.

Materials to be avoided in microwave oven

Utensils	Remarks
Aluminum tray	May cause arcing. Transfer food into microwave-safe dish.
Food carton with metal handle	May cause arcing. Transfer food into microwave-safe dish.
Metal or metal-trimmed utensils	Metal shields the food from microwave energy. Metal trim may cause arcing.
Metal twist ties	May cause arcing and could cause a fire in the oven.
Paper bags	May cause a fire in the oven.
Plastic foam	Plastic foam may melt or contaminate the liquid inside when exposed to high temperature.
Wood	Wood will dry out when used in the microwave oven and may split or crack.

PART NAMES

FRONT VIEW

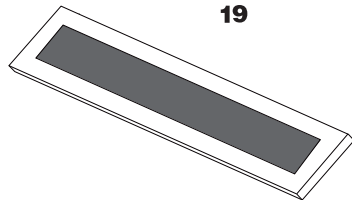
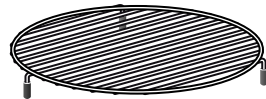
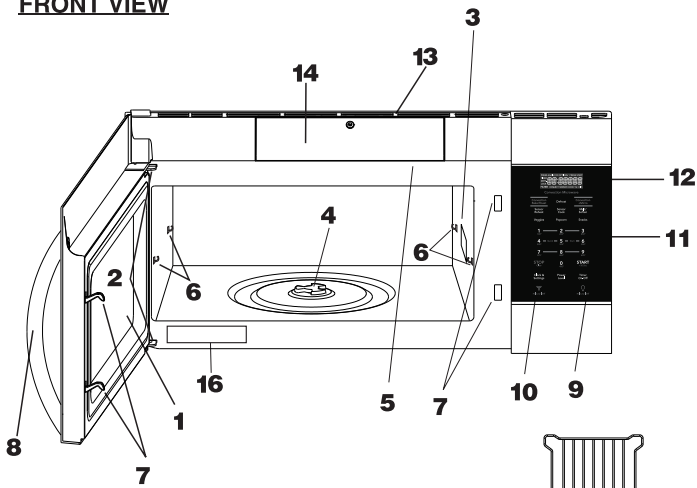

15

BOTTOM VIEW

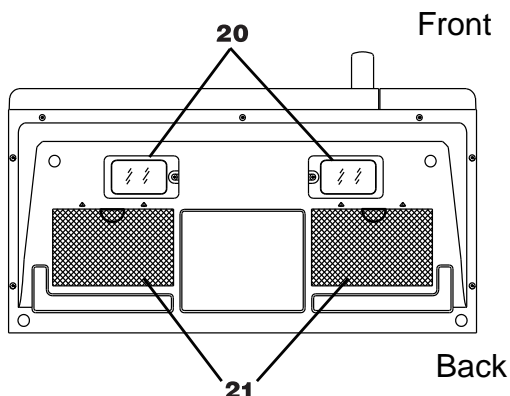

- 1 Microwave oven door with see-through window
- 2 Door hinges
- 3 Waveguide cover:
DO NOT REMOVE.
- 4 Turntable motor shaft
- 5 Microwave oven light
It will light when microwave oven is operating or door is open.
- 6 Rack holders
- 7 Safety door latches
The microwave oven will not operate unless the door is securely closed.
- 8 Handle
- 9 Light hi/lo/off pad
Press the **light hi/lo/off** pad once for high, twice for low and three times to turn off the light.
- 10 Vent hi/lo/off pad
Press the **vent hi/lo/off** pad once for high speed, twice for low speed and three times to turn off the fan.
- 11 Auto-Touch control panel
- 12 Time display: Digital display, 99 minutes, 99 seconds
- 13 Ventilation openings
- 14 Filter Access Door
- 15 Charcoal Filter
- 16 Menu label
- 17 Removable turntable
The turntable will rotate clockwise or counter-clockwise. Only remove for cleaning.
- 18 Removable turntable support
First, carefully place the turntable support on the motor shaft in the center of the microwave oven floor. Place the support ring on the microwave oven floor. Then, place the turntable on the turntable support securely.
- 19 Rack for 2-level cooking/ reheating
- 20 Light cover/Filter Access Door
- 21 Grease filters

CONTROL PANEL

The 7-digit Interactive Display spells out operating steps and shows cooking hints.

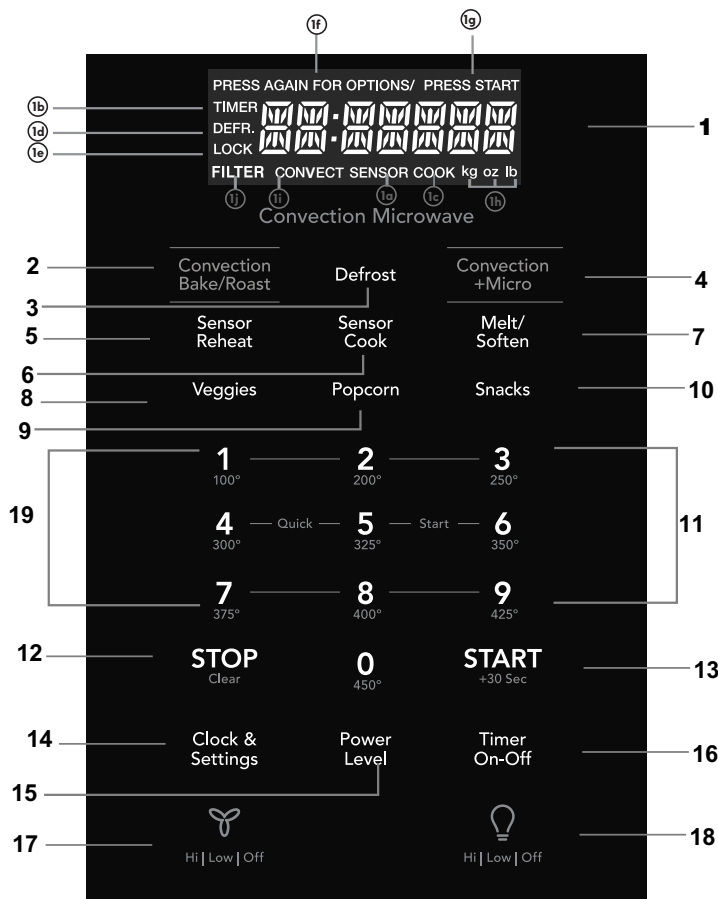

Number next to the control panel key illustration indicates pages on which there are feature descriptions and usage information.

(1) Display:

The display includes a clock and indicators that show the time of day, cooking time settings, cook powers, sensor, quantities, weights and cooking functions selected.

1a. SENSOR:

Icon displayed when using sensor cook.

1b. TIMER:

Icon displayed when timer is being set or running.

1c. COOK:

Icon displayed when starting microwave cooking.

1d. DEFR:

Icon displayed when defrosting food.

1e. LOCK:

Icon displayed in control lock.

1f. PRESS AGAIN FOR OPTIONS:

Icon displayed when additional options are available.

1g. PRESS START:

Icon displayed when a valid function can be started.

1h. kg, oz, lb:

Icon displayed when choosing the weight.

1i. CONVECT:

Icon displayed when choosing convection.

1j. FILTER:

Icon displayed replace Filter.

(2) Convection Bake/Roast

(3) Defrost

(4) Convection+Micro

(5) Sensor Reheat (5 different settings)

(6) Sensor Cook

(7) Melt Soften

(8) Veggies

(9) Popcorn

(10) Snacks

(11) Numeric pads (0 thru 9)

(12) Stop/Clear

(13) START +30 sec

(14) Clock & Settings

(15) Power Level (11 power levels available)

(16) Timer (On-Off)

(17) Exhaust (High/Low/Off) ~ Use to turn the exhaust fan off, or to adjust fan speed.

(18) Surface Light (High/Low/Off)

Press this pad to adjust the brightness of surface lights.

(19) Quick Start (9 instant key settings)

Note:For detailed information,please go to relative page listed above.

BEFORE OPERATING

- Before operating your new oven make sure you read and understand this Use and Care Guide completely.
- The clock can be disabled when the microwave is first plugged in and the STOP key is selected.
To re-enable the clock follow clock instructions.

To Set the Clock

- Suppose you want to enter the correct time of day 10:59

Touch:	Display Shows:
1. Clock & Settings	12:00 ENTER TIME <small>PRESS AGAIN FOR OPTIONS/</small>
2. (1) (0) (5) (9)	10:59 <small>PRESS START</small>
3. START +30 Sec	10:59

NOTE

1. If you begin to enter in an incorrect time (e.g. 2:89) the 8 is an invalid digit and cannot be entered. Enter the correct time.
2. If you touch **STOP** while setting the clock, the display will show the last time of day set or a blank display if no time of day has been set.

STOP clear

Press the **STOP** to:
Clear

1. Erase if you make a mistake during programming.
2. Cancel timer setting and the signal after cooking.
3. Stop the oven temporarily during cooking.
4. Return the time of day to the display.
5. Cancel a program during cooking, press twice.

MANUAL COOKING

Time Cooking

Your Over the Range Microwave Oven can be programmed for 99 minutes 99 seconds (99 :99). Always enter the seconds after the minutes, even if they are both zeros.

- Suppose you want to cook for 5 minutes, 30 seconds at 100% power,

Touch:	Display Shows:
1. (5) (3) (0)	5:30 <small>PRESS START</small>
2. START +30 Sec	5:30 <small>COOK</small> Time counting down

Interrupting Cooking

You can stop the oven during a cycle by opening the door. The oven stops heating and the fan turns off, but the light stays on.

To restart cooking, close the door and Touch.

START
+30 Sec

If you do not want to continue cooking, open the

door and touch **STOP**
Clear

Using One Touch Start

This is a time saving pad that will automatically start cooking 2 seconds after selected. Numeric key 1, 2, 3.....or 9 can be touched for a 1 minute, 2 minutes or 9 minutes automatic start cooking feature.

Touch:	Display Shows:
1. (2)	2:00 <small>COOK</small> Time counting down

NOTE

"Food" will be displayed if a quick start cooking cycle or +30 sec key is not selected within 5 minutes of placing food in the microwave. You must open then close the door again to clear "Food" from the display.

MANUAL COOKING

Using Add 30 Sec.

This is a time-saving pad. It is a simplified feature that lets you quickly set and start microwave cooking at 100% power.

- Suppose you want to cook for one minute.

Touch:	Display Shows:
1. START +30 Sec	
2. START +30 Sec	 Time counting down

NOTE

"Food" will be displayed if a quick start cooking cycle or +30 sec key is not selected within 5 minutes of placing food in the microwave. You must open then close the door again to clear "Food" from the display.

Setting Timed Cooking With Power Level

This feature lets you program a specific cook time and power. For best results, there are 11 power level settings in addition to HIGH (100%) power.

- Suppose you want to cook for 5 minutes, 30 seconds at 80% power.

Touch:	Display Shows:
1.	
2. Power Level x 3	
3. START +30 Sec	 Time counting down

NOTE

If you do not select a power level, the oven will automatically cook at HIGH (100%) power.

Setting Two-Stage Cooking

For best results, some recipes call for different power levels during a cook cycle. You can program your oven for two power level stages during the cooking cycle.

- Suppose you want to set a 2-stage cook cycle. The first stage is a 3 minute cook time at 80% cook power then a 7 minute cook time at 50% cook power.

Touch:	Display Shows:
1.	 To set a 3 minute cook time for first stage.
2. Power Level x 3	
3.	 To set a 7 minute cook power for the second stage.
4. Power Level x 6	

NOTE

You can program a "0" power second stage for standing time inside the oven.

5. START +30 Sec	 Time counting down
---------------------	------------------------

MANUAL COOKING

To Set Power Level

There are eleven preset power levels.

Using lower power levels increases the cooking time which is recommended for foods such as cheese, milk and long slow cooking of meats. Consult cookbook or recipes for specific recommendations.

PRESS POWER LEVEL PAD NUMBER OF TIMES FOR DESIRED POWER	APPROXIMATE PERCENTAGE OF POWER	COMMON WORDS FOR POWER LEVELS
POWER LEVEL x 1	100%	High
POWER LEVEL x 2	90%	
POWER LEVEL x 3	80%	
POWER LEVEL x 4	70%	Medium High
POWER LEVEL x 5	60%	
POWER LEVEL x 6	50%	Medium
POWER LEVEL x 7	40%	
POWER LEVEL x 8	30%	Med Low/Defrost
POWER LEVEL x 9	20%	
POWER LEVEL x 10	10%	Low
POWER LEVEL x 11	0%	



NOTE

DO NOT STORE THE RACK IN THE MICROWAVE WHEN NOT IN USE.

Using the Rack

The rack allows several foods to be cooked or reheated at one time. However, for the best cooking and reheating, use Turntable ON function and cook with SENSOR COOKING or AUTO COOKING without the rack. When the rack is used, set time and power level manually. Allow plenty of space around and between the dishes. Pay close attention to the cooking and reheating progress. Reposition the foods and reverse them from the rack to turntable and/or stir them at least once during any cooking or reheating time. After cooking or reheating, stir if possible. Using a lower power level will assist in better cooking and reheating uniformity.

Avoid:

- Storing the rack in the microwave oven when not in use.
- Popping popcorn with the rack in the microwave oven.
- Using any browning dish on the rack.
- Using SENSOR COOKING and AUTO COOKING with the rack.
- Cooking directly on the rack—use microwave-safe cookware.



NOTE

Turntable on/off function can be used in Manual Operation. See page 28.

Manual Defrost

If the food that you wish to defrost is not listed on the Defrost chart or is above or below the limits in the Amount column on the Defrost chart (see page 22-23), you need to defrost manually.

You can defrost any frozen food, either raw or previously cooked, by using power level for 30%.

For either raw or previously cooked frozen food the rule of thumb is approximately 4 minutes per pound. For example, defrost 4 minutes for 1 pound of frozen spaghetti sauce.

Always stop the oven periodically to remove or separate the portions that are defrosted. If food is not defrosted at the end of the estimated defrosting time, program the oven in 1 minute increments on power level 30% until totally defrosted.

When using plastic containers from the freezer, defrost only long enough to remove from the plastic in order to place in a microwave-safe dish.

SENSOR COOKING

Sensor cooking has an electronic controlled sensor that detects the vapor (moisture and humidity) emitted from the food as it heats. The sensor adjusts the cooking times and power level for various foods and quantities automatically.

Using Sensor Settings:

1. Be sure the exterior of the cooking container and the interior of the oven are dry. Wipe off any moisture with a dry cloth or paper towel.
2. The oven works with foods at normal storage temperature. For example, popcorn would be at room temperature.
3. More or less food than the quantity listed in the chart should be cooked following the guidelines in any microwave cookbook.
4. During the first part of SENSOR COOKING, food name will appear in the display. Do not open the oven door or press the **STOP clear** pad during this part of the cycle. The measurement of vapor will be interrupted. When the sensor detects the vapor emitted from the food, remainder of cooking time will appear. Door may be opened when remaining cooking time appears in the display. At this time, you may stir or season food, as desired.
5. If the sensor does not detect vapor properly when popping popcorn, the oven will turn off, and the correct time of day will be displayed. If the sensor does not detect vapor properly when cooking other foods, AN ERROR CODE will be displayed, and the oven will turn off.
6. Check food for temperature after cooking. If additional time is needed, continue to cook manually.

Covering Foods:

Some foods cook better when covered.

1. Casserole lid.
2. Plastic wrap: Use plastic wrap recommended for microwave cooking. Cover dish loosely; allow approximately 1/2 inch to remain uncovered to allow steam to escape. Plastic wrap should not touch food.
3. Wax paper: Cover dish completely; fold excess wrap under dish to secure. If dish is wider than paper, overlap two pieces at least one inch to cover.

Be careful when removing any covering to allow steam to escape away from you.



NOTES for SENSOR COOKING

1. The final cooking result will vary according to the food condition (e.g. initial temperature, shape, quality). Check food for temperature after cooking. If additional time is needed, continue to cook manually.
2. Stay near the oven while it's in use and check cooking progress frequently so that there is no chance of overcooking food.
3. When SENSOR COOKING is selected Turntable On is automatically set for optimum cooking.

Sensor Cook

You can cook foods by pressing the **sensor cook** pad multiple times. You don't need to calculate cooking time or power level.

- Suppose you want to cook frozen breakfast .

Touch:	Display Shows:
1. Sensor Cook	<small>PRESS AGAIN FOR OPTIONS/ PRESS START</small> BACON <small>SENSOR</small>
2. Sensor Cook	<small>PRESS AGAIN FOR OPTIONS/ PRESS START</small> FROZEN DINNER <small>SENSOR</small>
3. Sensor Cook	<small>PRESS AGAIN FOR OPTIONS/ PRESS START</small> RICE <small>SENSOR</small>
4. Sensor Cook	<small>PRESS AGAIN FOR OPTIONS/ PRESS START</small> FROZEN BREAKFAST <small>SENSOR</small>
5. Sensor Cook	<small>PRESS AGAIN FOR OPTIONS/ PRESS START</small> FROZEN PIZZA <small>SENSOR</small>
6. START +30 Sec	FROZEN PIZZA <small>SENSOR COOK</small>

SENSOR COOKING

Sensor Cook chart

FOOD	AMOUNT	PROCEDURE
1. Bacon	1-3 slices	Place bacon strips on a microwave bacon rack for best results. (Use dinner plate lined with paper towels if rack is not available).
2. Frozen Dinner	10 oz./ 20 oz.	Place in an appropriately sized microwave container. Cover with plastic wrap . After cooking, stir and allow to stand for 3 minutes.
3. Rice	1-2 cups Use medium or long grain rice. Cook instant rice according to directions on the package.	Place rice and twice as much liquid (water, chicken or vegetable stock) in a 2 quart microwave dish. Cover with plastic wrap and vent. After cooking, allow to stand for 10 minutes. Stir for fluffier rice.
4. Frozen Breakfast	8-12 oz.	Place in an appropriately sized microwave container. Cover with plastic wrap . After cooking, stir and allow to stand for 3 minutes.
5. Frozen Pizza	12 oz.	Place in an appropriately sized microwave container. Cover with plastic wrap . After cooking, stir and allow to stand for 3 minutes.

Sensor Reheat

- Suppose you want to reheat rolls with sensor reheat.

Touch:

Display Shows:

1. Sensor Reheat

PRESS AGAIN FOR OPTIONS/ PRESS START
BEVERAGE
SENSOR

2. Sensor Reheat

PRESS AGAIN FOR OPTIONS/ PRESS START
PIZZA
SENSOR

3. Sensor Reheat

PRESS AGAIN FOR OPTIONS/ PRESS START
SOUP SAUCE
SENSOR

4. Sensor Reheat

PRESS AGAIN FOR OPTIONS/ PRESS START
CASSEROLE
SENSOR

5. START
+30 Sec

CASSEROLE
SENSOR

Sensor Reheat chart

FOOD	AMOUNT	PROCEDURE
Beverage	1 - 3 cups	To reheat beverages. Stir liquid briskly before and after heating to avoid "eruption .
Pizza	1-4 Pieces	Use for pizza. Remove from package and unwrap. Follow package directions for use of package and/or silver crisping disk.
Soup/Sauce	1 Cup	Place in shallow microwavable casserole. Cover with vented plastic wrap. After cooking, stir and let stand 3 minutes.
Casserole/ Lasagna	10.5 Oz	Place in a microwavable bowl or casserole. Cover with vented plastic wrap. After cooking, stir and let stand 3 minutes.

ONE TOUCH COOK

Popcorn

The Popcorn quick touch pad lets you pop 3.3, 3.0, 1.75 ounce bags of commercially packaged microwave popcorn. Pop only one package at a time. If you are using a microwave popcorn popper, follow manufacturer's instructions.

- Suppose you want to pop a 3.3 oz. popcorn.

Touch: _____ Display Shows: _____

- | | |
|----------------------------|--|
| 1. Popcorn | <small>PRESS AGAIN FOR OPTIONS/ PRESS START</small>
3.3
<small>oz</small> |
| 2. START
+30 Sec | POPCORN
<small>COOK</small>
Time counting down |

Veggies

There are 3 options (Potato, Frozen Vegetables, Fresh Vegetables) under the Veggies.

- Suppose you want to cook two cups of frozen veggies.

Touch: _____ Display Shows: _____

- | | |
|------------|--|
| 1. Veggies | <small>PRESS START</small>
POTATO
<small>SENSOR</small> |
|------------|--|

Vegetables chart

FOOD (Initial temperature)	AMOUNT	PROCEDURE
Potato	1 - 4 pieces	Cooking times are based on an average 8 ounce potato. Pierce with fork in several places. Place on paper towel on turntable. Press the veggies pad one time for potato. After cooking, remove from oven and let stand for 5 minutes.
Fresh Vegetables (5 °C) Broccoli Brussels sprouts Cabbage Cauliflower (flowerets) Cauliflower (whole) Spinach Zucchini	2 cups	Wash and place in casserole. Add no water if vegetables have just been washed. Cover with lid for tender vegetables. Use plastic wrap for tender-crisp vegetables. Press the veggies pad twice for fresh Vegetables . After cooking, stir, if possible. Let stand, covered, for 2 to 5 minutes.
Carrots, sliced Corn on cob Green beans Winter squash - diced - halves		Place in casserole. Add 1-4 tbsp. water. Cover with lid for tender vegetables. Use plastic wrap cover for tender-crisp vegetables. Press the veggies pad twice for fresh vegetables. After cooking stir, if possible. Let stand, covered, for 2 to 5 minutes.
Frozen Vegetables (-18°C)	2 cups	Add no water. Cover with lid or plastic wrap. Press the veggies pad three times for Frozen Vegetables After cooking, stir and let stand, covered, for 3 minutes.

Amount	Press popcorn pad
3.30 oz.	once
3.00 oz.	2 times
1.75 oz.	3 times

NOTES

1. Remove the metal shelf from microwave oven when cooking popcorn. Do not use regular paper bags. Do not re-pop unpopped kernals. Do not pop popcorn in glass cookware.

Touch: _____ Display Shows: _____

- | | |
|----------------------------|--|
| 2. Veggies | <small>PRESS AGAIN FOR OPTIONS/ PRESS START</small>
FRESH
VEGGIES |
| 3. Veggies | <small>PRESS AGAIN FOR OPTIONS/ PRESS START</small>
FROZEN
VEGGIES |
| 4. START
+30 Sec | FROZEN VEGGIES
<small>COOK</small>
Time counting down |

ONE TOUCH COOK

Snack Menu

Snack Menu is for cooking/heating foods that take a short amount of time!

- Suppose you want to reheat hot dogs.

Touch: _____ Display Shows: _____

1. Snacks three times.

PRESS AGAIN FOR OPTIONS/ PRESS START
HOT 0005
SENSOR

2. START +30 Sec

1-6

3. ②

PRESS START
2

4. START +30 Sec

HOT 0005
COOK
Time counting down

Snack Menu chart

FOOD	AMOUNT	PROCEDURE
1. Chocolate Chip Cookies	12 cookies	To reheat chocolate chip cookies. Follow package directions for use of package and/or silver crisping disk. Press the Snack pad once for chocolate chip cookies. Then press START to preheat the food to 350 F. At this time, put the food into the oven, then press START to start cooking. After cooking, stir, if possible. Let stand, covered, for 2 to 5 minutes.
2. Frozen MW Pizza	6 - 8 oz (170 - 225 g)	Use for frozen microwave pizza. Remove from package and unwrap. Follow package directions for use of package and/or silver crisping disk. Press the Snack pad twice for frozen Microwave Pizza.
3. Hot Dogs	1 - 6 pieces	Place hot dog in bun. Wrap each with paper towel or napkin. Press the Snack pad three times for hot dogs. Press START to confirm the menu. Press numerical pads to choose the portions. Press START to start cooking.
4. Frozen Kid's Meal	8.8 oz	Press the Snack pad four times for frozen kids meal. Use this pad for frozen, convenience foods. It will give satisfactory results for most brands. You may wish to try several and choose your favorite. Remove package from outer wrapping and follow package directions for covering. After cooking, let stand, covered for 1 to 3 minutes.
5. Meal in a Cup	2.39 oz	Press the Snack pad five times for meal in a cup. This setting is ideal for individual portions of canned food packed in a small microwaveable container, usually 6 to 8 ounces. Remove inner metal lid and replace outer microwaveable lid. After cooking, stir food and allow to stand 1 or 2 minutes.
6. Soup	1 - 2 cups	To reheat Soup. Press the Snack pad six times for soup. Stir liquid briskly before and after heating to avoid "eruption" .

ONE TOUCH COOK

Setting Melt/Soften

The oven uses low power to melt and soften items. See the following table.

- Suppose you want to melt 2 sticks of Butter.

Touch:	Display Shows:
1. Melt/Soften	<small>PRESS AGAIN FOR OPTIONS/ PRESS START</small> MELT BUTTER
2. START +30 Sec	ENTER 1-2 STK
3. ②	<small>PRESS START</small> 2 STICK
4. START +30 Sec	MELT BUTTER <small>COOK</small> Time counting down

MELT TABLE

CATEGORY	AMOUNT	DIRECTION
BUTTER	1 or 2 sticks	Unwrap and place in microwavable container. No need to cover butter. Stir at the end of cooking to complete melting.
CHOCOLATE	2, 4 or 8 oz.	Chocolate chips or squares of baking chocolate may be used. Unwrap squares and place in microwavable container. Stir at the end of cycle to complete melting.
ICE CREAM	Pint, 1.5 Quart.	Place container in oven. Ice cream will be soft enough to make scooping easier.
CREAM CHEESE	3 or 8 oz.	Unwrap and place in microwavable container. Cream cheese will be at room temperature and ready for use in recipe.

CONVECTION COOKING

Convection Cooking

There are ten temperatures of convection: 100F, 200F, 250F, 300F, 325F, 350F, 375F, 400F, 425F, 450F.

Convection cooking uses a heating element to raise the temperature of the air inside the oven. Any oven temperature from 100°F to 450°F may be set. A fan gently circulates this heated air throughout the oven, over and around the food, producing golden brown exteriors and rich, moist interiors.

Because the heated air is kept constantly moving, not permitting a layer of cooler air to develop around the food, some foods cook faster than in regular oven cooking.

For Best Results...

Always use the round wire rack when convection cooking. Reduce package/recipe temperature 25°F for baked goods. The round wire rack is required for good air circulation and even browning.

See the *Cookware Tips* section (P21) for information on suggested cookware.

Using convection with preheating

- Suppose you want to cook food for 5 minutes at 400°F using convection with preheating

Touch:	Display Shows:
1. Convection Bake/Roast	<small>PRESS AGAIN FOR OPTIONS/ PRESS START</small> PREHEAT ENTER TEMP
2. (8)	<small>PRESS START</small> 400F
3. START +30 Sec (The oven is preheated, it will signal.)	PREHEAT <small>CONVECT</small>
4. When preheated temp. reached. If no action taken in 12 seconds, preheated temp. display.	400F <small>CONVECT</small>
5. Open the door in 30 minutes.	ENTER TIME
6. 5 0 0 325° 450° 450° Place the food in the oven. Press the number keys to set cooking time	5:00 <small>PRESS START</small>
7. START +30 Sec	Time counting down

Using convection without preheating

- Suppose you want to cook food for 5 minutes at 400°F using convection without preheating

Touch:	Display Shows:
1. Convection Bake/Roast	<small>PRESS AGAIN FOR OPTIONS/ PRESS START</small> PREHEAT ENTER TEMP
2. Convection Bake/Roast	<small>PRESS AGAIN FOR OPTIONS/ PRESS START</small> BAKE ROAST ENTER TEMP
3. (8)	<small>PRESS START</small> 400F
4. START +30 Sec	ENTER TIME
5. 5 0 0 325° 450° 450°	5:00 <small>PRESS START</small>
6. START +30 Sec	Time counting down

Microwave+Convection Combination Cooking

- Suppose you want to cook food for 5 minutes using combination cooking.

Touch:	Display Shows:
1. Convection +Micro	<small>PRESS AGAIN FOR OPTIONS/ PRESS START</small> BAKE 325 F
2. START +30 Sec	ENTER TIME
3. 5 0 0 325° 450° 450°	5:00 <small>PRESS START</small>
4. START +30 Sec	Time counting down

NOTES

- Check the *Cookware Tips* section for correct cookware when *Combination Cooking*
- Do not use metal cookware when *Combination Cooking*
- For best roasting and browning results, whole roasts should be cooked in a glass dish placed directly on the oven shelf.
- For foods that are too tall to fit in the oven, you may take out the round wire rack and place the dish directly on the turntable.

CONVECTION COOKING

Convection Cooking

- Use the round wire rack during convection baking.
- Always pre-heat the oven before convection baking.
- Avoid opening the oven door during cooking – each time the door is opened the oven loses heat and this can cause uneven baking.

Biscuits and bread

TYPE	TEMPERATURE	TIME	NOTES
Biscuits	400°F	20-30 minutes	Canned refrigerated biscuits take 2 to 4 minutes less time.
Muffins	350°F	15-20 minutes	Remove from tin straight away and place on cooling rack.
Nut bread or fruit bread	350°F	55-70 minutes	
Bread	350°F	55-65 minutes	
Plain or sweet rolls	350°F	40-50 minutes	Lightly grease baking sheet.

Cakes

TYPE	TEMPERATURE	TIME	NOTES
Cheesecake	350°F	65-75 minutes	After baking open oven door slightly and leave cheesecake to stand in oven for 30 minutes
Coffee cake	350°F	30-40 minutes	
Cup cakes	350°F	20-30 minutes	
Fruit cake	300°F	85-95 minutes	
Gingerbread	350°F	40-45 minutes	

CONVECTION COOKING

Combination Cooking

Combination cooking helps to brown and crisp foods.

TYPE	QUANTITY	TIME	NOTES
Beefburgers	4oz	16-19 minutes for two	Place on microwave-proof plate, drain fat and turn halfway through cooking.
Beef rump roast	1.0kg	Rare: 15-20 minutes Medium: 21-25 minutes Well done: 26-30 minutes	Place fat side down on low rack, season, shield if necessary. After cooking, leave to stand for 15 minutes.
Lamb roast, rolled, boneless	1.0kg	Rare: 15-20 minutes Medium: 21-25 minutes Well done: 26-30 minutes	Place fat side down on low rack, brush with marinade and season, shield if necessary. After cooking, leave to stand for 15 minutes.
Pork	2 chops	Rare: 13-17 minutes Medium: 18-23 minutes Well done: 24-29 minutes	Place on high rack, brush with marinade and season. Cook until no longer pink or internal temperature reaches 170°F. Turn halfway through cooking. After cooking, cover with foil and leave to stand for 5 minutes.
Pork	4 chops	Rare: 15-19 minutes Medium: 20-25 minutes Well done: 26-32 minutes	Place on high rack, brush with marinade and season. Cook until no longer pink or internal temperature reaches 170°F. Turn halfway through cooking. After cooking, cover with foil and leave to stand for 5 minutes.
Pork loin roast, rolled, boneless	1.0kg	Rare: 20-25 minutes Medium: 26-30 minutes Well done: 30-35 minutes	Place fat side down on low rack, season, shield if necessary. After cooking, cover with foil and leave to stand for 15 minutes.
Chicken breasts	1 lb.	16-26 minutes	Wash and dry meat, remove skin, place thickest portion to outside on high rack.
Chicken boneless portions	1 lb.	13-24 minutes	Place on high rack, brush with butter and season as required. Turn halfway through cooking. Cook until no longer pink and juices run clear. After cooking, cover with foil and leave to stand for 3-5 minutes.
Chicken, whole	1.3kg	25-40 minutes	Wash and dry bird, place breast down on low rack, brush with butter and season as required. Turn and drain halfway through cooking. Cook until no longer pink and juices run clear. After cooking, cover with foil and leave to stand for 10 minutes. Temperature in thigh should be approx 185°F.

CONVECTION COOKING

Cookware Tips

Convection Cooking

Metal Pans are recommended for all types of baked products, but especially where browning or crusting is important.

Dark or dull finish metal pans are best for breads and pies because they absorb heat and produce crisper crust.

Shiny aluminum pans are better for cakes, cookies or muffins because these pans reflect heat and help produce a light tender crust.

Glass or Glass-Ceramic casserole or baking dishes are best suited for egg and cheese recipes due to the cleanability of glass.

Combination Cooking

Glass or Glass-Ceramic baking containers are recommended. Be sure not to use items with metal trim as it may cause arcing (sparking) with oven wall or oven shelf, damaging the cookware, the shelf or the oven.

Heat-Resistant Plastic microwave cookware (safe to 450°F) may be used, but it is not recommended for foods requiring crusting or all-around browning, because the plastic is a poor conductor of heat.

COOKWARE	MICROWAVE	CONVECTION	COMBINATION
<i>Heat-Resistant Glass, Glass-Ceramic (Pyrex®, Fire King®, Corning Ware®, etc.)</i>	Yes	Yes	Yes
<i>Metal</i>	No	Yes	No
<i>Non Heat-Resistant Glass</i>	No	No	No
<i>Microwave-Safe Plastics</i>	Yes	No	Yes
<i>Plastic Films and Wraps</i>	Yes	No	No
<i>Paper Products</i>	Yes	No	No
<i>Straw, Wicker and Wood</i>	Yes	No	No

*Use only microwave cookware that is safe to 450 °F.

AUTO DEFROST

Using Auto Defrost

The auto defrost feature provides you with the best defrosting method for frozen foods. The cooking guide will show you which defrost sequence is recommended for the food you are defrosting.

For added convenience, the Auto Defrost includes a built-in beep mechanism that reminds you to check, turn over, separate, or rearrange the food in order to get the best defrost results. Three different defrosting levels are provided:

1. MEAT
2. POULTRY
3. FISH

Available weight is 0.1-6.0 lbs

- Suppose you want to defrost 1.2 lbs of fish.

Touch:	Display Shows:
1. Defrost	<small>PRESS AGAIN FOR OPTIONS/ PRESS START</small> MEAT
2. Defrost	<small>PRESS AGAIN FOR OPTIONS/ PRESS START</small> POULTRY
3. Defrost	<small>PRESS AGAIN FOR OPTIONS/ PRESS START</small> FISH
4. START +30 Sec	ENTER WEIGHT
5. ① and ②	<small>PRESS START</small> 1.2
To enter weight	
6. START +30 Sec	<small>DEFRL</small> FISH Time counting down

NOTES

The oven will beep during the DEFROST cycle. At this time, open the door and turn, separate, or rearrange the food. Remove any portions that have thawed. Return frozen portions to the oven and touch **START +30 Sec** to resume the defrost cycle.

Operating Tips

- For best results, remove fish, shell fish, meat and poultry from its original closed paper or plastic package (wrapper). Otherwise, the wrap will hold steam and juice close to the foods, which can cause the outer surface of the foods to cook.
- For best results, roll your ground meat into a ball before freezing. During the DEFROST cycle, the microwave will signal when it is time to turn the meat over. Scrape off any excess frost from the meat and continue defrosting.
- Place foods in a shallow container or on a microwave roasting rack to catch drippings.

This table shows food type selections and the weights you can set for each type. For best results, loosen or remove covering on food.

KEY PRESS	Category	WEIGHTS YOU CAN SET (tenths of a pound)
Defrost x 1	Meat	0.1 to 6.0
Defrost x 2	Poultry	0.1 to 6.0
Defrost x 3	Fish	0.1 to 6.0

Weight conversion table

You are probably used to measuring food in pounds and ounces that are fractions of a pound (for example, 4 ounces equals 1/4 pound). However, in order to enter food weight in Auto Defrost, you must specify pounds and tenths of a pound.

If the weight on the food package is in fractions of a pound, you can use the following table to convert the weight to decimals.

Equivalent Weight	
OUNCES	DECIMAL WEIGHT
1.6	.10
3.2	.20
4.0	.25 One-Quarter Pound
4.8	.30
6.4	.40
8.0	.50 One-Half Pound
9.6	.60
11.2	.70
12.0	.75 Three-Quarters Pound
12.8	.80
14.4	.90
16.0	1.0 One Pound

NOTES

If between two decimal weights, choose the lower weight for the best defrosting results.

AUTO DEFROST

Auto Defrost Table

NOTE: Meat of irregular shape and large, fatty cuts of meat should have the narrow or fatty areas shielded with foil at the beginning of the defrost sequence.

Meat Settings

FOOD	SETTING	AT BEEP	SPECIAL INSTRUCTIONS
BEEF			
Ground Beef, Bulk	MEAT	Remove thawed portions with fork. Turn over. Return remainder to oven.	Do not defrost less than 1/4 lb. Freeze in ball shape.
Ground Beef, Patties	MEAT	Separate and rearrange.	Do not defrost less than 2 oz. patties. Depress center when freezing.
Round Steak	MEAT	Turn over. Cover warm areas with aluminum foil.	Place in a microwave safe dish.
Tenderloin Steak	MEAT	Turn over. Cover warm areas with aluminum foil.	Place in a microwave safe dish.
Stew Beef	MEAT	Remove thawed portions with fork. Separate remainder.	Place in a microwave safe dish.
Pot Roast, Chuck Roast	MEAT	Return remainder to oven.	Place in a microwave safe dish.
Rib Roast	MEAT	Turn over. Cover warm areas with aluminum foil.	Place in a microwave safe dish.
Rolled Rump Roast	MEAT	Turn over. Cover warm areas with aluminum foil.	Place in a microwave safe dish.
LAMB			
Cubes for Stew	MEAT	Turn over. Cover warm areas with aluminum foil.	Place in a microwave safe dish.
Chops (1 inch thick)	MEAT	Remove thawed portions with fork. Return remainder to oven.	Place in a microwave safe dish.
PORK			
Chops (1/2 inch thick)	MEAT	Separate and rearrange.	Place in a microwave safe dish.
Hot Dogs	MEAT	Separate and rearrange.	Place in a microwave safe dish.
Spareribs Country-style Ribs	MEAT	Turn over. Cover warm areas with aluminum foil.	Place in a microwave safe dish.
Sausage, Links	MEAT	Separate and rearrange.	Place in a microwave safe dish.
Sausage, Bulk	MEAT	Remove thawed portions with fork. Turn over. Return remainder to oven.	Place in a microwave safe dish.
Loin Roast, Boneless	MEAT	Turn over. Cover warm areas with aluminum foil.	Place in a microwave safe dish.

AUTO DEFROST

Auto Defrost Table (Continued)

Poultry Settings

FOOD	SETTING	AT BEEP	SPECIAL INSTRUCTIONS
CHICKEN Whole (up to 6 lbs) Cut-up	POULTRY	Turn over breast side down. Cover warm areas with aluminum foil. Separate pieces and rearrange. Turn over. Cover warm areas with aluminum foil.	Place chicken breast-side up in a microwave safe dish. Finish defrosting by immersing in cold water. Remove giblets when chicken is partially defrosted. Place in a microwave safe dish. Finish defrosting by immersing in cold water.
CORNISH HENS Whole	POULTRY	Turn over. Cover warm areas with aluminum foil.	Place in a microwave safe dish. Finish defrosting by immersing in cold water.
TURKEY Breast (up to 6 lbs)	POULTRY	Turn over. Cover warm areas with aluminum foil.	Place in a microwave safe dish. Finish defrosting by immersing in cold water.

Fish Settings

FOOD	SETTING	AT BEEP	SPECIAL INSTRUCTIONS
FISH Fillets	FISH	Turn over. Separate fillets when partially thawed, if possible.	Place in a microwave safe dish. Carefully separate fillets under cold water.
Steaks	FISH	Separate and rearrange.	Place in a microwave safe dish. Run cold water over to finish defrosting.
Whole	FISH	Turn over	Place in a microwave safe dish. Cover head and tail with foil; do not let foil touch sides of microwave. Finish defrosting by immersing in cold water.
SHELLFISH Crab meat	FISH	Break apart. Turn over.	Place in a microwave safe dish.
Lobster tails	FISH	Turn over and rearrange.	Place in a microwave safe dish.
Shrimp	FISH	Separate and rearrange.	Place in a microwave safe dish.
Scallops	FISH	Separate and rearrange.	Place in a microwave safe dish.

Defrosting Tips

- When using Auto Defrost, the weight to be entered is the net weight in pounds and tenths of pounds (the weight of the food minus the container).
- Before starting, make sure to remove any and all metal twist-ties that often come with frozen food bags, and replace them with strings or elastic bands.
- Open containers, such as cartons, before placing in the oven.
- Always slit or pierce plastic pouches or packaging.
- If food is foil wrapped, remove foil and place food in a suitable container.
- Slit the skin of skinned food, such as sausage.
- Bend plastic pouches of food to ensure even defrosting.
- Always underestimate defrosting time. If defrosted food is still icy in the center, return it to the microwave oven for more defrosting.
- The length of defrosting time varies according to how solidly the food is frozen.
- The shape of the package affects how quickly food will defrost. Shallow packages will defrost more quickly than a deep block.
- As food begins to defrost, separate the pieces. Separated pieces defrost more easily.
- Use small pieces of aluminum foil to shield parts of food such as chicken wings, leg tips, fish tails, or areas that start to get warm. Make sure the foil does not touch the sides, top, or bottom of the oven. The foil can damage the oven lining.
- For better results, let food stand after defrosting.
- Turn over food during defrosting or standing time. Break apart and remove food as required.

CONVENIENT FEATURES

Clock & Settings

The microwave oven has settings that allow you to customize the operation for your convenience. Below is the table showing the various settings. Touch the Clock & Settings key multiple times to scroll to the desired setting function.

Key press	Option
Clock & Settings x1	Clock
Clock & Settings x2	Control Lock
Clock & Settings x3	Power Save
Clock & Settings x4	Volume Low/Med/High/Off
Clock & Settings x5	Pure Air Filter Reset/Off
Clock & Settings x6	Language
Clock & Settings x7	Weight lb/kg
Clock & Settings x8	Demo

(1). Setting Clock

The clock can be disabled when the microwave is first plugged in and the **STOP**_{Clear} key is selected.

To re-enable the clock follow clock instructions.

- Suppose you want to set the clock for 10:59.

Touch:	Display Shows:
1. Clock & Settings	<small>PRESS AGAIN FOR OPTIONS/</small> 12:00 ENTER TIME
2. (1) (0) (5) (9)	<small>PRESS START</small> 10:59
3. START +30 Sec	10:59

NOTE

1. If you begin to enter in an incorrect time (e.g. 2:89) the 8 is an invalid digit and cannot be entered. Enter the correct time.
2. If you touch **STOP**_{Clear} while setting the clock, the display will show the last time of day set or a blank display if no time of day has been set.

(2).Setting Control Lock On/Off

To turn ON Control Lock .

Touch:	Display Shows:
1. Clock & Settings	<small>PRESS AGAIN FOR OPTIONS/</small> 12:00 ENTER TIME
2. Clock & Settings	<small>PRESS AGAIN FOR OPTIONS/ PRESS START</small> CONTROL LOCK
3. START +30 Sec	Time of day if time of day was set LOCK

To turn OFF the Control Lock, touch Clock & Settings then touch **START**
+30 Sec

(3).Setting Power Save On/Off

To turn ON Power Save. Turning ON power save turns off the time of day clock display.

Touch:	Display Shows:
1. Clock & Settings	<small>PRESS AGAIN FOR OPTIONS/</small> 12:00 ENTER TIME
2. Clock & Settings	<small>PRESS AGAIN FOR OPTIONS/ PRESS START</small> CONTROL LOCK
3. Clock & Settings	<small>PRESS AGAIN FOR OPTIONS/ PRESS START</small> POWER SAVE OFF
4. START +30 Sec	ON

To turn OFF the Power Save, touch Clock & Settings and choose POWER SAVE, select OFF then touch **START**
+30 Sec .

CONVENIENT FEATURES

(4).Turning Sound Low/Med/High/Off

Audible signals are available to guide you when setting and using your oven.

- **A programming tone** will sound each time you touch a pad.
- **Three tones** signal the end of a Kitchen Timer count down.
- **Three tones** signal the end of a cooking cycle.
- Suppose you want to turn audible signal off.

Touch:	Display Shows:
1. Clock & Settings	<small>PRESS AGAIN FOR OPTIONS/</small> 12:00 ENTER TIME
2. Clock & Settings	<small>PRESS AGAIN FOR OPTIONS/ PRESS START</small> CONTROL LOCK
3. Clock & Settings	<small>PRESS AGAIN FOR OPTIONS/ PRESS START</small> POWER SAVE OFF
4. Clock & Settings	<small>PRESS AGAIN FOR OPTIONS/ PRESS START</small> VOLUME ON
	<small>PRESS AGAIN FOR OPTIONS/ PRESS START</small> VOLUME OFF
	<small>PRESS AGAIN FOR OPTIONS/ PRESS START</small> VOLUME LOW
	<small>PRESS AGAIN FOR OPTIONS/ PRESS START</small> VOLUME MED
	<small>PRESS AGAIN FOR OPTIONS/ PRESS START</small> VOLUME HIGH
5. START +30 Sec	OFF

NOTE

When the cooking cycle is completed END will be displayed and the audible signal will sound if the sound is turned on.

(5)SETTING FILTER RESET OR FILTER OFF

- Suppose you want to set the filter reset to off.

Touch:	Display Shows:
1. Clock & Settings	<small>PRESS AGAIN FOR OPTIONS/</small> 12:00 ENTER TIME
2. Clock & Settings	<small>PRESS AGAIN FOR OPTIONS/ PRESS START</small> CONTROL LOCK
3. Clock & Settings	<small>PRESS AGAIN FOR OPTIONS/ PRESS START</small> POWER SAVE OFF
4. Clock & Settings	<small>PRESS AGAIN FOR OPTIONS/ PRESS START</small> VOLUME OFF ON
5. Clock & Settings	<small>PRESS AGAIN FOR OPTIONS/ PRESS START</small> FILTER RESET
6. START +30 Sec	<small>PRESS AGAIN FOR OPTIONS/ PRESS START</small> FILTER OFF
	OFF

NOTE

Select FILTER RESET to turn off "FILTER" icon and reset to remind in 6 months; if you want to turn off "FILTER" icon notification and not remind at all, select FILTER OFF and press START +30 Sec .

CONVENIENT FEATURES

(6) SETTING LANGUAGE ENGLISH/FRANCAIS

- Suppose you want to set the language.

Touch:	Display Shows:
--------	----------------

- | | |
|---------------------|---|
| 1. Clock & Settings | <small>PRESS AGAIN FOR OPTIONS/</small>
12:00 ENTER TIME |
| 2. Clock & Settings | <small>PRESS AGAIN FOR OPTIONS/ PRESS START</small>
CONTROL LOCK |
| 3. Clock & Settings | <small>PRESS AGAIN FOR OPTIONS/ PRESS START</small>
POWER SAVE OFF |
| 4. Clock & Settings | <small>PRESS AGAIN FOR OPTIONS/ PRESS START</small>
VOLUME OFF
ON |
| 5. Clock & Settings | <small>PRESS AGAIN FOR OPTIONS/ PRESS START</small>
FILTER RESET |
| 6. Clock & Settings | <small>PRESS AGAIN FOR OPTIONS/ PRESS START</small>
LANGUAGE FRENCH |
| 7. START
+30 Sec | FRANCAIS |

NOTE

When **START** +30 Sec is pressed and the previous setting was English it will be set to French. If you want switch back to English you will have to again press **Clock & Settings** five times and then press **START** +30 Sec.

(7). Setting Weight Lb/Kg

- Suppose you want to toggle weight between pounds & kilograms.

Touch:	Display Shows:
--------	----------------

- | | |
|---------------------|---|
| 1. Clock & Settings | <small>PRESS AGAIN FOR OPTIONS/</small>
12:00 ENTER TIME |
| 2. Clock & Settings | <small>PRESS AGAIN FOR OPTIONS/ PRESS START</small>
CONTROL LOCK |
| 3. Clock & Settings | <small>PRESS AGAIN FOR OPTIONS/ PRESS START</small>
POWER SAVE OFF |
| 4. Clock & Settings | <small>PRESS AGAIN FOR OPTIONS/ PRESS START</small>
VOLUME OFF
ON |
| 5. Clock & Settings | <small>PRESS AGAIN FOR OPTIONS/ PRESS START</small>
FILTER RESET |
| 6. Clock & Settings | <small>PRESS AGAIN FOR OPTIONS/ PRESS START</small>
LANGUAGE FRENCH |
| 7. Clock & Settings | <small>PRESS AGAIN FOR OPTIONS/ PRESS START</small>
LB / KG |
| 8. START
+30 Sec | KG |

NOTE

If the display shows kg, pressing the **START** +30 Sec button will reset the oven controls to lbs. To return to kg, you will have to again press **Clock & Settings** six times and then press **START** +30 Sec.

CONVENIENT FEATURES

(8).Setting Demo Mode On/Of

- Suppose you want to enter Demo mode. When Demo mode is ON programming functions will work in a rapid countdown mode with no cooking power.

Touch:	Display Shows:
1. Clock & Settings	<small>PRESS AGAIN FOR OPTIONS/</small> 12:00 ENTER TIME
2. Clock & Settings	<small>PRESS AGAIN FOR OPTIONS/ PRESS START</small> CONTROL LOCK
3. Clock & Settings	<small>PRESS AGAIN FOR OPTIONS/ PRESS START</small> POWER SAVE OFF
4. Clock & Settings	<small>PRESS AGAIN FOR OPTIONS/ PRESS START</small> VOLUME OFF ON
5. Clock & Settings	<small>PRESS AGAIN FOR OPTIONS/ PRESS START</small> FILTER RESET
6. Clock & Settings	<small>PRESS AGAIN FOR OPTIONS/ PRESS START</small> LANGUAGE FRANCH
7. Clock & Settings	<small>PRESS AGAIN FOR OPTIONS/ PRESS START</small> LB / KG
8. Clock & Settings	<small>PRESS AGAIN FOR OPTIONS/ PRESS START</small> DEMO OFF
9. START +30 Sec	ON

NOTE

When **START** +30 Sec is pressed and the previous setting was OFF then it will be set to ON. If you want to turn the demo mode back OFF you will have to again press **Clock & Settings** seven times and then press **START** +30 Sec.

2. Setting Kitchen Timer

Your microwave oven can be used as a kitchen timer. You can set up to 99 minutes, 99 seconds. The kitchen timer can be used while the microwave oven is running.

- Suppose you want to set for three minutes.

Touch:	Display Shows:
1. Timer On-Off	<small>TIMER</small> ENTER TIME
2. (3) (0) (0)	<small>TIMER</small> 3:00
3. Timer On-Off	<small>TIMER</small> 3:00 Timer starts counting down



NOTE

Timer count down does not stop even if the door is open. When timer and cooking both are working, press "**Timer On-Off**" once, the display would show the remaining timer; to cancel the timer, press "**Timer On-Off**" once again. When only timer working, press "**Timer On-Off**" once to cancel the timer.

3.Using Vent Fan

The pad controls the 2-speed vent fan. If the vent fan is OFF the first touch of the Vent pad will turn the fan on HIGH, second touch LOW and third touch OFF.

- Suppose you want to set the vent fan speed to LOW from the OFF position.

Touch:	Display Shows:
1. 	HIGH
Hi Low Off	
2. 	LOW
Hi Low Off	

CONVENIENT FEATURES

NOTE

If the temperature from the range or cooktop below the oven gets too hot, the vent fan will automatically turn on to protect the oven. It may stay on up to an hour to cool the oven. When this occurs, the Vent pad will not turn the fan off.

4.Using Cooktop Light

The pad controls the cooktop light. If the light is OFF the first touch of the light pad will turn the light ON (high), second touch Nite (low) and third touch OFF.

- Suppose you want to set the light for HIGH from the OFF position.

Touch:	Display Shows:
1.  Hi Low Off	HIGH

MAINTENANCE

Troubleshooting

Check your problem by using the chart below and try the solutions for each problem. If the microwave oven still does not work properly, contact the nearest authorized service center.

TROUBLE	POSSIBLE CAUSE	POSSIBLE REMEDY
Oven will not start	<ul style="list-style-type: none"> a. Electrical cord for oven is not plugged in. b. Door is open. c. Wrong operation is set. 	<ul style="list-style-type: none"> a. Plug into the outlet. b. Close the door and try again. c. Check instructions.
Arcing or sparking	<ul style="list-style-type: none"> a. Materials to be avoided in microwave oven were used. b. The oven is operated when empty. c. Spilled food remains in the cavity. 	<ul style="list-style-type: none"> a. Use microwave-safe cookware only. b. Do not operate with oven empty. c. Clean cavity with wet towel.
Unevenly cooked foods	<ul style="list-style-type: none"> a. Materials to be avoided in microwave oven were used. b. Food is not defrosted completely. c. Cooking time, power level is not suitable. d. Food is not turned or stirred. 	<ul style="list-style-type: none"> a. Use microwave-safe cookware only. b. Completely defrost food. c. Use correct cooking time, power level. d. Turn or stir food.
Overcooked foods	Cooking time, power level is not suitable.	Use correct cooking time, power level.
Undercooked foods	<ul style="list-style-type: none"> a. Materials to be avoided in microwave oven were used. b. Food is not defrosted completely. c. Oven ventilation ports are restricted. d. Cooking time, power level is not suitable. 	<ul style="list-style-type: none"> a. Use microwave-safe cookware only. b. Completely defrost food. c. Check to see that oven ventilation ports are not restricted. d. Use correct cooking time, power level.
Improper defrosting	<ul style="list-style-type: none"> a. Materials to be avoided in microwave oven were used. b. Cooking time, power level is not suitable. c. Food is not turned or stirred. 	<ul style="list-style-type: none"> a. Use microwave-safe cookware only. b. Use correct cooking time, power level. c. Turn or stir food.

BEFORE YOU CALL FOR SERVICE

Refer to the following checklist before you call for service.

If oven does not work:

1. Check that power cord is securely plugged in.
2. Check that door is firmly closed.
3. Check that the cooking time is set.
4. Check for tripped circuit breaker.

If there is sparking in the cavity:

Check the containers, dishes or utensils in the oven and make sure they are not metal or metal trim.

 <p>HIGH POINTE AUTHORIZED SERVICE</p>	<p>TO FIND THE LOCATION AND PHONE NUMBER OF YOUR NEAREST AUTHORIZED SERVICE CENTER...</p>
<p>CALL 1-574-848-1630 OR EMAIL WARRANTY DEPT@ COLLINS-N-CO.COM</p>	

FOR CUSTOMER SERVICE, PLEASE WRITE TO:

High Point
COLLINS & COMPANY
17880 COMMERCE DRIVE
PO BOX 1009
BRISTOL, INDIANA 46507